

PILOT'S OPERATING HANDBOOK

and

FAA APPROVED AIRPLANE FLIGHT MANUAL

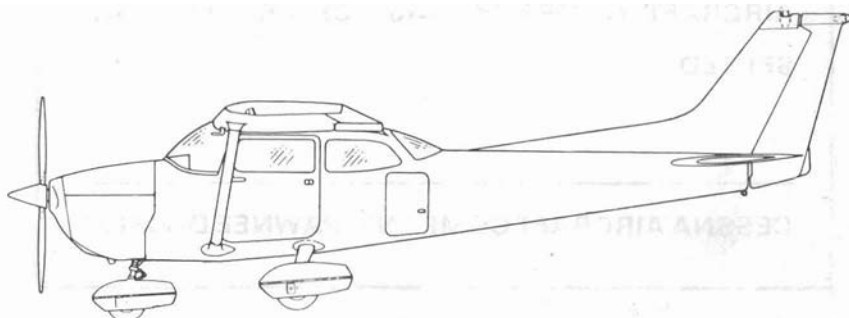

CESSNA AIRCRAFT COMPANY

1980 MODEL 172N

THIS DOCUMENT MUST BE
CARRIED IN THE AIRPLANE
AT ALL TIMES.

Serial No. 172 73831

Registration No. OY-BHI

THIS HANDBOOK INCLUDES THE MATERIAL REQUIRED TO BE
FURNISHED TO THE PILOT BY CAR PART 3 AND CONSTITUTES
THE FAA APPROVED AIRPLANE FLIGHT MANUAL.

COPYRIGHT © 1979

CESSNA AIRCRAFT COMPANY
WICHITA, KANSAS, USA

THIS MANUAL WAS PROVIDED FOR THE AIRPLANE IDENTIFIED ON THE TITLE PAGE ON _____ .
SUBSEQUENT REVISIONS SUPPLIED BY CESSNA AIRCRAFT COMPANY MUST BE PROPERLY INSERTED.

CESSNA AIRCRAFT COMPANY, PAWNEE DIVISION

This manual is issued to replace one originally provided for the airplane identified on the cover page on 02-15-80 . All revisions, if any, have been incorporated as of 02-24-95

Subsequent revisions supplied by Cessna Aircraft Company must be properly inserted.

Emily Parsons
Cessna Aircraft Company

CONGRATULATIONS

Welcome to the ranks of Cessna owners! Your Cessna has been designed and constructed to give you the most in performance, economy, and comfort. It is our desire that you will find flying it, either for business or pleasure, a pleasant and profitable experience.

This Pilot's Operating Handbook has been prepared as a guide to help you get the most pleasure and utility from your airplane. It contains information about your Cessna's equipment, operating procedures, and performance; and suggestions for its servicing and care. We urge you to read it from cover to cover, and to refer to it frequently.

Our interest in your flying pleasure has not ceased with your purchase of a Cessna. World-wide, the Cessna Dealer Organization backed by the Cessna Customer Services Department stands ready to serve you. The following services are offered by most Cessna Dealers:

THE CESSNA WARRANTY, which provides coverage for parts and labor, is available at Cessna Dealers worldwide. Specific benefits and provisions of warranty, plus other important benefits for you, are contained in your Customer Care Program book, supplied with your airplane. Warranty service is available to you at authorized Cessna Dealers throughout the world upon presentation of your Customer Care Card which establishes your eligibility under the warranty.

- FACTORY TRAINED PERSONNEL to provide you with courteous expert service.
- FACTORY APPROVED SERVICE EQUIPMENT to provide you efficient and accurate workmanship.
- A STOCK OF GENUINE CESSNA SERVICE PARTS on hand when you need them

THE LATEST AUTHORITATIVE INFORMATION FOR SERVICING CESSNA AIRPLANES, since Cessna Dealers have all of the Service Manuals and Parts Catalogs, kept current by Service Letters and Service News Letters, published by Cessna Aircraft Company.

We urge all Cessna owners to use the Cessna Dealer Organization to the fullest.

A current Cessna Dealer Directory accompanies your new airplane. The Directory is revised frequently, and a current copy can be obtained from your Cessna Dealer. Make your Directory one of your cross-country flight planning aids; a warm welcome awaits you at every Cessna Dealer.

PERFORMANCE - SPECIFICATIONS

SPEED:

Maximum at Sea Level	125 KNOTS
Cruise, 75% Power at 8000 Ft	122 KNOTS

CRUISE: Recommended lean mixture with fuel allowance for engine start, taxi, takeoff, climb and 45 minutes reserve.

75% Power at 8000 Ft	Range	455 NM
40 Gallons Usable Fuel	Time	3.8 HRS
75% Power at 8000 Ft	Range	600 NM
50 Gallons Usable Fuel	Time	5.0 HRS
Maximum Range at 10,000 Ft	Range	575 NM
40 Gallons Usable Fuel	Time	6.1 HRS
Maximum Range at 10,000 Ft	Range	750 NM
50 Gallons Usable Fuel	Time	7.9 HRS

RATE OF CLIMB AT SEA LEVEL 770 FPM

SERVICE CEILING 14,200 FT

TAKEOFF PERFORMANCE:

Ground Roll	775 FT
Total Distance Over 50-Ft Obstacle	1390 FT

LANDING PERFORMANCE:

Ground Roll	520 FT
Total Distance Over 50-Ft Obstacle	1250 FT

STALL SPEED (CAS):

Flaps Up, Power Off	50 KNOTS
Flaps Down, Power Off	44 KNOTS

MAXIMUM WEIGHT:

Ramp	2307 LBS
Takeoff or Landing	2300 LBS

STANDARD EMPTY WEIGHT:

Skyhawk	1403 LBS
Skyhawk II	1430 LBS

MAXIMUM USEFUL LOAD:

Skyhawk	904 LBS
Skyhawk II	877 LBS

BAGGAGE ALLOWANCE 120 LBS

WING LOADING: Pounds/Sq Ft 13.2

POWER LOADING: Pounds/HP 14.4

FUEL CAPACITY: Total

Standard Tanks	43 GAL.
Long Range Tanks	54 GAL.

OIL CAPACITY 6 QTS

ENGINE: Avco Lycoming O-320-H2AD

160 BHP at 2700 RPM

PROPELLER: Fixed Pitch, Diameter 75 IN.

COVERAGE

The Pilot's Operating Handbook in the airplane at the time of delivery from Cessna Aircraft Company contains information applicable to the 1980 Model 172N airplane designated by the serial number and registration number shown on the Title Page of this handbook.

REVISIONS

Changes and/or additions to this handbook will be covered by revisions published by Cessna Aircraft Company. These revisions are distributed to all Cessna Dealers and to owners of U. S. Registered aircraft according to FAA records at the time of revision issuance.

Revisions should be examined immediately upon receipt and incorporated in this handbook.

NOTE

It is the responsibility of the owner to maintain this handbook in a current status when it is being used for operational purposes.

Owners should contact their Cessna Dealer whenever the revision status of their handbook is in question.

A revision bar will extend the full length of new or revised text and/or illustrations added on new or presently existing pages. This bar will be located adjacent to the applicable revised area on the outer margin of the page.

All revised pages will carry the revision number and date on the applicable page.

The following Log of Effective Pages provides the dates of issue for original and revised pages, and a listing of all pages in the handbook. Pages affected by the current revision are indicated by an asterisk (*) preceding the pages listed.

LOG OF EFFECTIVE PAGES

Dates of issue for original and revised pages are:

Original 1 July 1979
Revision 1 15 November 1979

Page	Date	Page	Date
Title	1 July 1979	5-22 Blank	1 July 1979
Assignment Record	1 July 1979	6-1	1 July 1979
i thru ii	1 July 1979	6-2 Blank	1 July 1979
*iii	15 November 1979	6-3 thru 6-23	1 July 1979
iv	1 July 1979	6-24 Blank	1 July 1979
1-1 thru 1-3	1 July 1979	7-1 thru 7-17	1 July 1979
*1-4	15 November 1979	*7-18	15 November 1979
1-5 thru 1-9	1 July 1979	7-19 thru 7-40	1 July 1979
1-10 Blank	1 July 1979	8-1	1 July 1979
2-1	1 July 1979	8-2 Blank	1 July 1979
2-2 Blank	1 July 1979	8-3 thru 8-9	1 July 1979
2-3 thru 2-12	1 July 1979	*8-10 thru 8-11	15 November 1979
3-1 thru 3-9	1 July 1979	8-12 thru 8-17	1 July 1979
3-10 Blank	1 July 1979	8-18 Blank	1 July 1979
3-11 thru 3-18	1 July 1979	9-1 thru 9-2	1 July 1979
4-1 thru 4-20	1 July 1979		
*4-21	15 November 1979		
4-22 thru 4-24	1 July 1979		
5-1	1 July 1979		
5-2 Blank	1 July 1979		
5-3 thru 5-21	1 July 1979		

NOTE

Refer to Section 9 Table of Contents for supplements applicable to optional systems.

1 July 1979

Revision 1 - 15 November 1979 D1172-1-13PH-RPC-1000-3/80

iii

TABLE OF CONTENTS

	SECTION
GENERAL.....	1
LIMITATIONS.....	2
EMERGENCY PROCEDURES.....	3
NORMAL PROCEDURES.....	4
PERFORMANCE.....	5
WEIGHT & BALANCE/ EQUIPMENT LIST	6
AIRPLANE & SYSTEMS DESCRIPTIONS	7
AIRPLANE HANDLING, SERVICE & MAINTENANCE	8
SUPPLEMENTS (Optional Systems Description & Operating Procedures)	9

SECTION 1 GENERAL

TABLE OF CONTENTS

	Page
Three View	1-2
Introduction	1-3
Descriptive Data	1-3
Engine	1-3
Propeller	1-3
Fuel	1-3
Oil	1-4
Maximum Certificated Weights	1-5
Standard Airplane Weights	1-5
Cabin And Entry Dimensions	1-5
Baggage Space And Entry Dimensions	1-5
Specific Loadings	1-5
Symbols, Abbreviations And Terminology	1-6
General Airspeed Terminology And Symbols	1-6
Meteorological Terminology	1-6
Engine Power Terminology	1-7
Airplane Performance And Flight Planning Terminology	1-7
Weight And Balance Terminology	1-8

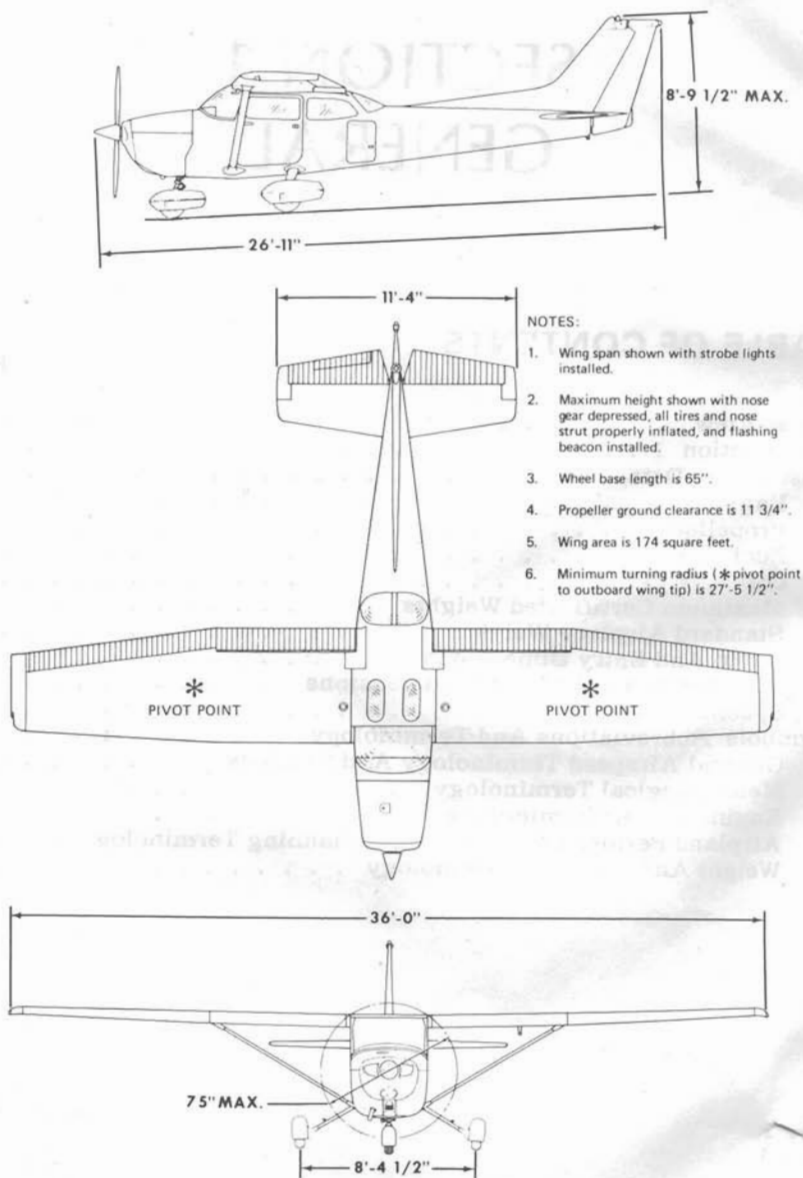

Figure 1-1. Three View

INTRODUCTION

This handbook contains 9 sections, and includes the material required to be furnished to the pilot by CAR Part 3. It also contains supplemental data supplied by Cessna Aircraft Company.

Section 1 provides basic data and information of general interest. It also contains definitions or explanations of symbols, abbreviations, and terminology commonly used.

DESCRIPTIVE DATA

ENGINE

Number of Engines: 1.

Engine Manufacturer: Avco Lycoming.

Engine Model Number: O-320-H2AD.

Engine Type: Normally-aspirated, direct-drive, air-cooled, horizontally-opposed, carburetor equipped, four-cylinder engine with 320 cu. in. displacement.

Horsepower Rating and Engine Speed: 160 rated BHP at 2700 RPM.

PROPELLER

Propeller Manufacturer: McCauley Accessory Division.

Propeller Model Number: 1C160/DTM7557.

Number of Blades: 2.

Propeller Diameter, Maximum: 75 inches.

Minimum: 74 inches.

Propeller Type: Fixed pitch.

FUEL

Approved Fuel Grades (and Colors):

100LL Grade Aviation Fuel (Blue).

100 (Formerly 100/130) Grade Aviation Fuel (Green).

NOTE

Isopropyl alcohol or ethylene glycol monomethyl ether may be added to the fuel supply. Additive concentrations shall not exceed 1% for isopropyl alcohol or .15% for ethylene glycol monomethyl ether. Refer to Section 8 for additional information.

Fuel Capacity:

Standard Tanks:

Total Capacity: 43 gallons.

Total Capacity Each Tank: 21.5 gallons.

Total Usable: 40 gallons.

Long Range Tanks:

Total Capacity: 54 gallons.

Total Capacity Each Tank: 27 gallons.

Total Usable: 50 gallons.

NOTE

To ensure maximum fuel capacity when refueling and minimize cross-feeding when parked on a sloping surface, place the fuel selector valve in either LEFT or RIGHT position.

OIL

Oil Grade (Specification):

MIL-L-22851 Ashless Dispersant Oil: The airplane was delivered from the factory with SAE 20W-50 ashless dispersant aircraft engine oil. Ashless dispersant aircraft engine oil **must be used** for all operating conditions.

NOTE

Use a minimum of 75% power for cruise during the first 50 hours of operation or until oil consumption stabilizes. Service the engine oil system with **aviation ashless dispersant oil** only.

Required Viscosity for Temperature Range:

MIL-L-22851 Ashless Dispersant Oil:

SAE 20W-50 or SAE 15W-50 for all temperatures.

NOTE

If multi-viscosity ashless dispersant aircraft engine oil is not available, the following ashless dispersant aircraft engine oil may be used.

SAE 50 above 60°F (16°C).

SAE 40 between 30°F (-1°C) and 90°F (32°C).

SAE 30 between 0°F (-18°C) and 70°F (21°C).

SAE 20W-30 below 0°F (-18°C) to 70°F (21°C).

Oil Capacity:

Sump: 6 Quarts.

Total: 7 Quarts (if oil filter installed).

MAXIMUM CERTIFICATED WEIGHTS

Ramp, Normal Category: 2307 lbs.

Utility Category: 2007 lbs.

Takeoff, Normal Category: 2300 lbs.

Utility Category: 2000 lbs.

Landing, Normal Category: 2300 lbs.

Utility Category: 2000 lbs.

Weight in Baggage Compartment, Normal Category:

Baggage Area 1 (or passenger on child's seat) - Station 82 to 108: 120 lbs. See note below.

Baggage Area 2 - Station 108 to 142: 50 lbs. See note below.

NOTE

The maximum combined weight capacity for baggage areas 1 and 2 is 120 lbs.

Weight in Baggage Compartment, Utility Category: In this category, the baggage compartment and rear seat must not be occupied.

STANDARD AIRPLANE WEIGHTS

Standard Empty Weight, Skyhawk: 1403 lbs.

Skyhawk II: 1430 lbs.

Maximum Useful Load:

	Normal Category	Utility Category
Skyhawk:	904 lbs.	604 lbs.
Skyhawk II:	877 lbs.	577 lbs.

CABIN AND ENTRY DIMENSIONS

Detailed dimensions of the cabin interior and entry door openings are illustrated in Section 6.

BAGGAGE SPACE AND ENTRY DIMENSIONS

Dimensions of the baggage area and baggage door opening are illustrated in detail in Section 6.

SPECIFIC LOADINGS

Wing Loading: 13.2 lbs./sq. ft.

Power Loading: 14.4 lbs./hp.

SYMBOLS, ABBREVIATIONS AND TERMINOLOGY

GENERAL AIRSPEED TERMINOLOGY AND SYMBOLS

- KCAS** **Knots Calibrated Airspeed** is indicated airspeed corrected for position and instrument error and expressed in knots. Knots calibrated airspeed is equal to KTAS in standard atmosphere at sea level.
- KIAS** **Knots Indicated Airspeed** is the speed shown on the airspeed indicator and expressed in knots.
- KTAS** **Knots True Airspeed** is the airspeed expressed in knots relative to undisturbed air which is KCAS corrected for altitude and temperature.
- V_A **Maneuvering Speed** is the maximum speed at which you may use abrupt control travel.
- V_{FE} **Maximum Flap Extended Speed** is the highest speed permissible with wing flaps in a prescribed extended position.
- V_{NO} **Maximum Structural Cruising Speed** is the speed that should not be exceeded except in smooth air, then only with caution.
- V_{NE} **Never Exceed Speed** is the speed limit that may not be exceeded at any time.
- V_S **Stalling Speed or the minimum steady flight speed** at which the airplane is controllable.
- V_{S_0} **Stalling Speed or the minimum steady flight speed** at which the airplane is controllable in the landing configuration at the most forward center of gravity.
- V_X **Best Angle-of-Climb Speed** is the speed which results in the greatest gain of altitude in a given horizontal distance.
- V_Y **Best Rate-of-Climb Speed** is the speed which results in the greatest gain in altitude in a given time.

METEOROLOGICAL TERMINOLOGY

- OAT** **Outside Air Temperature** is the free air static temperature.

It is expressed in either degrees Celsius or degrees Fahrenheit.

Standard
Temperature

Standard Temperature is 15°C at sea level pressure altitude and decreases by 2°C for each 1000 feet of altitude.

Pressure
Altitude

Pressure Altitude is the altitude read from an altimeter when the altimeter's barometric scale has been set to 29.92 inches of mercury (1013 mb).

ENGINE POWER TERMINOLOGY

BHP

Brake Horsepower is the power developed by the engine.

RPM

Revolutions Per Minute is engine speed.

Static
RPM

Static RPM is engine speed attained during a full-throttle engine runup when the airplane is on the ground and stationary.

AIRPLANE PERFORMANCE AND FLIGHT PLANNING TERMINOLOGY

Demon-
strated
Crosswind
Velocity

Demonstrated Crosswind Velocity is the velocity of the crosswind component for which adequate control of the airplane during takeoff and landing was actually demonstrated during certification tests. The value shown is not considered to be limiting.

Usable Fuel

Usable Fuel is the fuel available for flight planning.

Unusable
Fuel

Unusable Fuel is the quantity of fuel that can not be safely used in flight.

GPH

Gallons Per Hour is the amount of fuel (in gallons) consumed per hour.

NMPG

Nautical Miles Per Gallon is the distance (in nautical miles) which can be expected per gallon of fuel consumed at a specific engine power setting and/or flight configuration.

g

g is acceleration due to gravity.

WEIGHT AND BALANCE TERMINOLOGY

Reference Datum	Reference Datum is an imaginary vertical plane from which all horizontal distances are measured for balance purposes.
Station	Station is a location along the airplane fuselage given in terms of the distance from the reference datum.
Arm	Arm is the horizontal distance from the reference datum to the center of gravity (C.G.) of an item.
Moment	Moment is the product of the weight of an item multiplied by its arm. (Moment divided by the constant 1000 is used in this handbook to simplify balance calculations by reducing the number of digits.)
Center of Gravity (C.G.)	Center of Gravity is the point at which an airplane, or equipment, would balance if suspended. Its distance from the reference datum is found by dividing the total moment by the total weight of the airplane.
C.G. Arm	Center of Gravity Arm is the arm obtained by adding the airplane's individual moments and dividing the sum by the total weight.
C.G. Limits	Center of Gravity Limits are the extreme center of gravity locations within which the airplane must be operated at a given weight.
Standard Empty Weight	Standard Empty Weight is the weight of a standard airplane, including unusable fuel, full operating fluids and full engine oil.
Basic Empty Weight	Basic Empty Weight is the standard empty weight plus the weight of optional equipment.
Useful Load	Useful Load is the difference between ramp weight and the basic empty weight.
Maximum Ramp Weight	Maximum Ramp Weight is the maximum weight approved for ground maneuver. (It includes the weight of start, taxi, and runup fuel.)
Maximum Takeoff Weight	Maximum Takeoff Weight is the maximum weight approved for the start of the takeoff run.

Maximum
Landing
Weight

Maximum Landing Weight is the maximum weight approved for the landing touchdown.

Tare

Tare is the weight of chocks, blocks, stands, etc. used when weighing an airplane, and is included in the scale readings. Tare is deducted from the scale reading to obtain the actual (net) airplane weight.

1-20-1916
16111-17

MODERN
12200

Blank page with faint mirrored text from the reverse side.

Blank page with faint mirrored text from the reverse side.

Blank.

1-20-1916

12200

SECTION 2 LIMITATIONS

TABLE OF CONTENTS

	Page
Introduction	2-3
Airspeed Limitations	2-4
Airspeed Indicator Markings	2-5
Power Plant Limitations	2-5
Power Plant Instrument Markings	2-6
Weight Limits	2-6
Normal Category	2-6
Utility Category	2-7
Center Of Gravity Limits	2-7
Normal Category	2-7
Utility Category	2-7
Maneuver Limits	2-7
Normal Category	2-7
Utility Category	2-7
Flight Load Factor Limits	2-8
Normal Category	2-8
Utility Category	2-8
Kinds Of Operation Limits	2-9
Fuel Limitations	2-9
Other Limitations	2-9
Flap Limitations	2-9
Placards	2-10

SECTION 2
EXHIBIT

TABLE OF CONTENTS

Blank

Page 1
Page 2
Page 3
Page 4
Page 5
Page 6
Page 7
Page 8
Page 9
Page 10
Page 11
Page 12
Page 13
Page 14
Page 15
Page 16
Page 17
Page 18
Page 19
Page 20
Page 21
Page 22
Page 23
Page 24
Page 25
Page 26
Page 27
Page 28
Page 29
Page 30
Page 31
Page 32
Page 33
Page 34
Page 35
Page 36
Page 37
Page 38
Page 39
Page 40
Page 41
Page 42
Page 43
Page 44
Page 45
Page 46
Page 47
Page 48
Page 49
Page 50
Page 51
Page 52
Page 53
Page 54
Page 55
Page 56
Page 57
Page 58
Page 59
Page 60
Page 61
Page 62
Page 63
Page 64
Page 65
Page 66
Page 67
Page 68
Page 69
Page 70
Page 71
Page 72
Page 73
Page 74
Page 75
Page 76
Page 77
Page 78
Page 79
Page 80
Page 81
Page 82
Page 83
Page 84
Page 85
Page 86
Page 87
Page 88
Page 89
Page 90
Page 91
Page 92
Page 93
Page 94
Page 95
Page 96
Page 97
Page 98
Page 99
Page 100

INTRODUCTION

Section 2 includes operating limitations, instrument markings, and basic placards necessary for the safe operation of the airplane, its engine, standard systems and standard equipment. The limitations included in this section and in Section 9 have been approved by the Federal Aviation Administration. Observance of these operating limitations is required by Federal Aviation Regulations.

NOTE

Refer to Section 9 of this Pilot's Operating Handbook for amended operating limitations, operating procedures, performance data and other necessary information for airplanes equipped with specific options.

NOTE

The airspeeds listed in the Airspeed Limitations chart (figure 2-1) and the Airspeed Indicator Markings chart (figure 2-2) are based on Airspeed Calibration data shown in Section 5 with the normal static source. If the alternate static source is being used, ample margins should be observed to allow for the airspeed calibration variations between the normal and alternate static sources as shown in Section 5.

Your Cessna is certificated under FAA Type Certificate No. 3A12 as Cessna Model No. 172N.

AIRSPEED LIMITATIONS

Airspeed limitations and their operational significance are shown in figure 2-1. Maneuvering speeds shown apply to normal category operations. The utility category maneuvering speed is 97 KIAS at 2000 pounds.

	SPEED	KCAS	KIAS	REMARKS
V _{NE}	Never Exceed Speed	158	158	Do not exceed this speed in any operation.
V _{NO}	Maximum Structural Cruising Speed	126	127	Do not exceed this speed except in smooth air, and then only with caution.
V _A	Maneuvering Speed: 2300 Pounds 1950 Pounds 1600 Pounds	96 88 80	97 89 80	Do not make full or abrupt control movements above this speed.
V _{FE}	Maximum Flap Extended Speed: 10° Flaps 10° - 40° Flaps	110 87	110 85	Do not exceed this speed with flaps down.
	Maximum Window Open Speed	158	158	Do not exceed this speed with windows open.

Figure 2-1. Airspeed Limitations

AIRSPED INDICATOR MARKINGS

Airspeed indicator markings and their color code significance are shown in figure 2-2.

MARKING	KIAS VALUE OR RANGE	SIGNIFICANCE
White Arc	33 - 85	Full Flap Operating Range. Lower limit is maximum weight V_{S_0} in landing configuration. Upper limit is maximum speed permissible with flaps extended.
Green Arc	44 - 127	Normal Operating Range. Lower limit is maximum weight V_S at most forward C.G. with flaps retracted. Upper limit is maximum structural cruising speed.
Yellow Arc	127 - 158	Operations must be conducted with caution and only in smooth air.
Red Line	158	Maximum speed for all operations.

Figure 2-2. Airspeed Indicator Markings

POWER PLANT LIMITATIONS

Engine Manufacturer: Avco Lycoming.

Engine Model Number: O-320-H2AD.

Engine Operating Limits for Takeoff and Continuous Operations:

Maximum Power: 160 BHP rating.

Maximum Engine Speed: 2700 RPM.

NOTE

The static RPM range at full throttle (carburetor heat off and full rich mixture) is 2280 to 2400 RPM.

Maximum Oil Temperature: 245°F (118°C).

Oil Pressure, Minimum: 25 psi.

Maximum: 115 psi.

Propeller Manufacturer: McCauley Accessory Division.

Propeller Model Number: 1C160/DTM7557.

Propeller Diameter, Maximum: 75 inches.

Minimum: 74 inches.

POWER PLANT INSTRUMENT MARKINGS

Power plant instrument markings and their color code significance are shown in figure 2-3.

INSTRUMENT	RED LINE	GREEN ARC	YELLOW ARC	RED LINE
	MINIMUM LIMIT	NORMAL OPERATING	CAUTION RANGE	MAXIMUM LIMIT
Tachometer: Sea Level 5000 Feet 10000 Feet	---	2100-2450 RPM 2100-2575 RPM 2100-2700 RPM	---	2700 RPM
Oil Temperature	---	100°-245°F	---	245°F
Oil Pressure	25 psi	60-90 psi	---	115 psi
Fuel Quantity (Standard Tanks)	E (1.5 Gal. Unusable Each Tank)	---	---	---
Fuel Quantity (Long Range Tanks)	E (2.0 Gal. Unusable Each Tank)	---	---	---
Suction	---	4.5-5.4 in. Hg	---	---

Figure 2-3. Power Plant Instrument Markings

WEIGHT LIMITS

NORMAL CATEGORY

Maximum Ramp Weight: 2307 lbs.

Maximum Takeoff Weight: 2300 lbs.

Maximum Landing Weight: 2300 lbs.

Maximum Weight in Baggage Compartment:

Baggage Area 1 (or passenger on child's seat) - Station 82 to 108: 120 lbs. See note below.

Baggage Area 2 - Station 108 to 142: 50 lbs. See note below.

NOTE

The maximum combined weight capacity for baggage areas 1 and 2 is 120 lbs.

UTILITY CATEGORY

Maximum Ramp Weight: 2007 lbs.
Maximum Takeoff Weight: 2000 lbs.
Maximum Landing Weight: 2000 lbs.
Maximum Weight in Baggage Compartment: In the utility category, the baggage compartment and rear seat must not be occupied.

CENTER OF GRAVITY LIMITS

NORMAL CATEGORY

Center of Gravity Range:
Forward: 35.0 inches aft of datum at 1950 lbs. or less, with straight line variation to 38.5 inches aft of datum at 2300 lbs.
Aft: 47.3 inches aft of datum at all weights.
Reference Datum: Lower portion of front face of firewall.

UTILITY CATEGORY

Center of Gravity Range:
Forward: 35.0 inches aft of datum at 1950 lbs. or less, with straight line variation to 35.5 inches aft of datum at 2000 lbs.
Aft: 40.5 inches aft of datum at all weights.
Reference Datum: Lower portion of front face of firewall.

MANEUVER LIMITS

NORMAL CATEGORY

This airplane is certificated in both the normal and utility category. The normal category is applicable to aircraft intended for non-aerobatic operations. These include any maneuvers incidental to normal flying, stalls (except whip stalls), lazy eights, chandelles, and turns in which the angle of bank is not more than 60°. Aerobatic maneuvers, including spins, are not approved.

UTILITY CATEGORY

This airplane is not designed for purely aerobatic flight. However, in the acquisition of various certificates such as commercial pilot and flight instructor, certain maneuvers are required by the FAA. All of these maneuvers are permitted in this airplane when operated in the utility category.

In the utility category, the baggage compartment and rear seat must not be occupied. No aerobatic maneuvers are approved except those listed below:

MANEUVER	RECOMMENDED ENTRY SPEED*
Chandelles	105 knots
Lazy Eights	105 knots
Steep Turns	95 knots
Spins	Slow Deceleration
Stalls (Except Whip Stalls)	Slow Deceleration

*Abrupt use of the controls is prohibited above 97 knots.

Aerobatics that may impose high loads should not be attempted. The important thing to bear in mind in flight maneuvers is that the airplane is clean in aerodynamic design and will build up speed quickly with the nose down. Proper speed control is an essential requirement for execution of any maneuver, and care should always be exercised to avoid excessive speed which in turn can impose excessive loads. In the execution of all maneuvers, avoid abrupt use of controls. Intentional spins with flaps extended are prohibited.

FLIGHT LOAD FACTOR LIMITS

NORMAL CATEGORY

Flight Load Factors (Maximum Takeoff Weight - 2300 lbs.):

- *Flaps Up +3.8g, -1.52g
- *Flaps Down +3.0g

*The design load factors are 150% of the above, and in all cases, the structure meets or exceeds design loads.

UTILITY CATEGORY

Flight Load Factors (Maximum Takeoff Weight - 2000 lbs.):

- *Flaps Up +4.4g, -1.76g
- *Flaps Down +3.0g

*The design load factors are 150% of the above, and in all cases, the structure meets or exceeds design loads.

KINDS OF OPERATION LIMITS

The airplane is equipped for day VFR and may be equipped for night VFR and/or IFR operations. FAR Part 91 establishes the minimum required instrumentation and equipment for these operations. The reference to types of flight operations on the operating limitations placard reflects equipment installed at the time of Airworthiness Certificate issuance.

Flight into known icing conditions is prohibited.

FUEL LIMITATIONS

2 Standard Tanks: 21.5 U.S. gallons each.

Total Fuel: 43 U.S. gallons.

Usable Fuel (all flight conditions): 40 U.S. gallons.

Unusable Fuel: 3 U.S. gallons.

2 Long Range Tanks: 27 U.S. gallons each.

Total Fuel: 54 U.S. gallons.

Usable Fuel (all flight conditions): 50 U.S. gallons.

Unusable Fuel: 4 U.S. gallons.

NOTE

To ensure maximum fuel capacity when refueling and minimize cross-feeding when parked on a sloping surface, place the fuel selector valve in either LEFT or RIGHT position.

Takeoff and land with the fuel selector valve handle in the BOTH position.

Fuel remaining in the tank after the fuel quantity indicator reads empty (red line) cannot be safely used in flight.

Approved Fuel Grades (and Colors):

100LL Grade Aviation Fuel (Blue).

100 (Formerly 100/130) Grade Aviation Fuel (Green).

OTHER LIMITATIONS

FLAP LIMITATIONS

Approved Takeoff Range: 0° to 10°.

Approved Landing Range: 0° to 40°.

PLACARDS

The following information must be displayed in the form of composite or individual placards.

1. In full view of the pilot: (The "DAY-NIGHT-VFR-IFR" entry, shown on the example below, will vary as the airplane is equipped.)

The markings and placards installed in this airplane contain operating limitations which must be complied with when operating this airplane in the Normal Category. Other operating limitations which must be complied with when operating this airplane in this category or in the Utility Category are contained in the Pilot's Operating Handbook and FAA Approved Airplane Flight Manual.

Normal Category - No acrobatic maneuvers, including spins, approved.

Utility Category - No acrobatic maneuvers approved, except those listed in the Pilot's Operating Handbook.

Baggage compartment and rear seat must not be occupied.

Spin Recovery - Opposite rudder - forward elevator - neutralize controls.

Flight into known icing conditions prohibited.

This airplane is certified for the following flight operations as of date of original airworthiness certificate:

DAY-NIGHT-VFR-IFR

2. On the fuel selector valve (standard tanks):

BOTH - 40 GAL. ALL FLIGHT ATTITUDES.
TAKEOFF, LANDING.
LEFT - 20 GAL. LEVEL FLIGHT ONLY
RIGHT - 20 GAL. LEVEL FLIGHT ONLY
OFF

On the fuel selector valve (long range tanks):

BOTH - 50 GAL. ALL FLIGHT ATTITUDES.
TAKEOFF, LANDING.
LEFT - 25 GAL. LEVEL FLIGHT ONLY
RIGHT - 25 GAL. LEVEL FLIGHT ONLY
OFF

3. Near fuel tank filler cap (standard tanks):

FUEL
100LL/100 MIN. GRADE AVIATION GASOLINE
CAP. 21.5 U.S. GAL.

Near fuel tank filler cap (long range tanks):

FUEL
100LL/100 MIN. GRADE AVIATION GASOLINE
CAP. 27 U.S. GAL.

4. Near wing flap switch:

AVOID SLIPS WITH FLAPS EXTENDED

5. On flap control indicator:

0° to 10° (Partial flap range with blue color code and 110 kt callout; also, mechanical detent at 10°.)

10° to 40° (Indices at these positions with white color code and 85 kt callout; also, mechanical detent at 10° and 20°.)

6. In baggage compartment:

120 POUNDS MAXIMUM
BAGGAGE AND/OR AUXILIARY PASSENGER
FORWARD OF BAGGAGE DOOR LATCH

50 POUNDS MAXIMUM
BAGGAGE AFT OF BAGGAGE DOOR LATCH

MAXIMUM 120 POUNDS COMBINED

FOR ADDITIONAL LOADING INSTRUCTIONS
SEE WEIGHT AND BALANCE DATA

7. A calibration card is provided to indicate the accuracy of the magnetic compass in 30° increments.

8. On oil filler cap:

OIL
6 QTS

9. On control lock:

CONTROL LOCK - REMOVE BEFORE STARTING ENGINE

10. Near airspeed indicator:

MANEUVER SPEED - 97 KIAS

SECTION 3

EMERGENCY PROCEDURES

TABLE OF CONTENTS

	Page
Introduction	3-3
Airspeeds For Emergency Operation	3-3

OPERATIONAL CHECKLISTS

Engine Failures	3-3
Engine Failure During Takeoff Run	3-3
Engine Failure Immediately After Takeoff	3-4
Engine Failure During Flight	3-4
Forced Landings	3-4
Emergency Landing Without Engine Power	3-4
Precautionary Landing With Engine Power	3-4
Ditching	3-5
Fires	3-5
During Start On Ground	3-5
Engine Fire In Flight	3-6
Electrical Fire In Flight	3-6
Cabin Fire	3-7
Wing Fire	3-7
Icing	3-7
Inadvertent Icing Encounter	3-7
Static Source Blockage (Erroneous Instrument Reading Suspected)	3-8
Landing With A Flat Main Tire	3-8
Electrical Power Supply System Malfunctions	3-8
Ammeter Shows Excessive Rate of Charge (Full Scale Deflection)	3-8
Low-Voltage Light Illuminates During Flight (Ammeter Indicates Discharge)	3-9

AMPLIFIED PROCEDURES

Engine Failure	3-11
Forced Landings	3-12
Landing Without Elevator Control	3-12
Fires	3-12

TABLE OF CONTENTS (Continued)

	Page
Emergency Operation In Clouds (Vacuum System Failure)	3-13
Executing A 180° Turn In Clouds	3-13
Emergency Descent Through Clouds	3-13
Recovery From A Spiral Dive	3-14
Inadvertent Flight Into Icing Conditions	3-14
Static Source Blocked	3-14
Spins	3-15
Rough Engine Operation Or Loss Of Power	3-16
Carburetor Icing	3-16
Spark Plug Fouling	3-16
Magneto Malfunction	3-16
Low Oil Pressure	3-16
Electrical Power Supply System Malfunctions	3-17
Excessive Rate Of Charge	3-17
Insufficient Rate Of Charge	3-17

INTRODUCTION

Section 3 provides checklist and amplified procedures for coping with emergencies that may occur. Emergencies caused by airplane or engine malfunctions are extremely rare if proper preflight inspections and maintenance are practiced. Enroute weather emergencies can be minimized or eliminated by careful flight planning and good judgment when unexpected weather is encountered. However, should an emergency arise, the basic guidelines described in this section should be considered and applied as necessary to correct the problem. Emergency procedures associated with ELT and other optional systems can be found in Section 9.

AIRSPEEDS FOR EMERGENCY OPERATION

Engine Failure After Takeoff:

Wing Flaps Up	65 KIAS
Wing Flaps Down	60 KIAS

Maneuvering Speed:

2300 Lbs	97 KIAS
1950 Lbs	89 KIAS
1600 Lbs	80 KIAS

Maximum Glide	65 KIAS
-------------------------	---------

Precautionary Landing With Engine Power	60 KIAS
---	---------

Landing Without Engine Power:

Wing Flaps Up	65 KIAS
Wing Flaps Down	60 KIAS

OPERATIONAL CHECKLISTS

ENGINE FAILURES

ENGINE FAILURE DURING TAKEOFF RUN

1. Throttle -- IDLE.
2. Brakes -- APPLY.
3. Wing Flaps -- RETRACT.
4. Mixture -- IDLE CUT-OFF.
5. Ignition Switch -- OFF.
6. Master Switch -- OFF.

ENGINE FAILURE IMMEDIATELY AFTER TAKEOFF

1. Airspeed -- 65 KIAS (flaps UP).
60 KIAS (flaps DOWN).
2. Mixture -- IDLE CUT-OFF.
3. Fuel Selector Valve -- OFF.
4. Ignition Switch -- OFF.
5. Wing Flaps -- AS REQUIRED.
6. Master Switch -- OFF.

ENGINE FAILURE DURING FLIGHT

1. Airspeed -- 65 KIAS.
2. Carburetor Heat -- ON.
3. Fuel Selector Valve -- BOTH.
4. Mixture -- RICH.
5. Ignition Switch -- BOTH (or START if propeller is stopped).
6. Primer -- IN and LOCKED.

FORCED LANDINGS

EMERGENCY LANDING WITHOUT ENGINE POWER

1. Airspeed -- 65 KIAS (flaps UP).
60 KIAS (flaps DOWN).
2. Mixture -- IDLE CUT-OFF.
3. Fuel Selector Valve -- OFF.
4. Ignition Switch -- OFF.
5. Wing Flaps -- AS REQUIRED (40° recommended).
6. Master Switch -- OFF.
7. Doors -- UNLATCH PRIOR TO TOUCHDOWN.
8. Touchdown -- SLIGHTLY TAIL LOW.
9. Brakes -- APPLY HEAVILY.

PRECAUTIONARY LANDING WITH ENGINE POWER

1. Wing Flaps -- 20°.
2. Airspeed -- 60 KIAS.
3. Selected Field -- FLY OVER, noting terrain and obstructions, then retract flaps upon reaching a safe altitude and airspeed.
4. Avionics Power Switch and Electrical Switches -- OFF.
5. Wing Flaps -- 40° (on final approach).
6. Airspeed -- 60 KIAS.
7. Master Switch -- OFF.
8. Doors -- UNLATCH PRIOR TO TOUCHDOWN.

9. Touchdown -- SLIGHTLY TAIL LOW.
10. Ignition Switch -- OFF.
11. Brakes -- APPLY HEAVILY.

DITCHING

1. Radio -- TRANSMIT MAYDAY on 121.5 MHz, giving location and intentions and SQUAWK 7700 if transponder is installed.
2. Heavy Objects (in baggage area) -- SECURE OR JETTISON.
3. Approach -- High Winds, Heavy Seas -- INTO THE WIND.
Light Winds, Heavy Swells -- PARALLEL TO SWELLS.
4. Wing Flaps -- 20° - 40°.
5. Power -- ESTABLISH 300 FT/MIN DESCENT AT 55 KIAS.

NOTE

If no power is available, approach at 65 KIAS with flaps up or at 60 KIAS with 10° flaps.

6. Cabin Doors -- UNLATCH.
7. Touchdown -- LEVEL ATTITUDE AT ESTABLISHED RATE OF DESCENT.
8. Face -- CUSHION at touchdown with folded coat.
9. Airplane -- EVACUATE through cabin doors. If necessary, open window and flood cabin to equalize pressure so doors can be opened.
10. Life Vests and Raft -- INFLATE.

FIRES

DURING START ON GROUND

1. Cranking -- CONTINUE, to get a start which would suck the flames and accumulated fuel through the carburetor and into the engine.

If engine starts:

2. Power -- 1700 RPM for a few minutes.
3. Engine -- SHUTDOWN and inspect for damage.

If engine fails to start:

4. Throttle -- FULL OPEN.
5. Mixture -- IDLE CUT-OFF.

6. Cranking -- CONTINUE.
7. Fire Extinguisher -- OBTAIN (have ground attendants obtain if not installed).
8. Engine -- SECURE.
 - a. Master Switch -- OFF.
 - b. Ignition Switch -- OFF.
 - c. Fuel Selector Valve -- OFF.
9. Fire -- EXTINGUISH using fire extinguisher, wool blanket, or dirt.
10. Fire Damage -- INSPECT, repair damage or replace damaged components or wiring before conducting another flight.

ENGINE FIRE IN FLIGHT

1. Mixture -- IDLE CUT-OFF.
2. Fuel Selector Valve -- OFF.
3. Master Switch -- OFF.
4. Cabin Heat and Air -- OFF (except overhead vents).
5. Airspeed -- 100 KIAS (If fire is not extinguished, increase glide speed to find an airspeed which will provide an incombustible mixture).
6. Forced Landing -- EXECUTE (as described in Emergency Landing Without Engine Power).

ELECTRICAL FIRE IN FLIGHT

1. Master Switch -- OFF.
2. Avionics Power Switch -- OFF.
3. All Other Switches (except ignition switch) -- OFF.
4. Vents/Cabin Air/Heat -- CLOSED.
5. Fire Extinguisher -- ACTIVATE (if available).

WARNING

After discharging an extinguisher within a closed cabin, ventilate the cabin.

If fire appears out and electrical power is necessary for continuance of flight:

6. Master Switch -- ON.
7. Circuit Breakers -- CHECK for faulty circuit, do not reset.
8. Radio Switches -- OFF.
9. Avionics Power Switch -- ON.
10. Radio/Electrical Switches -- ON one at a time, with delay after each until short circuit is localized.

11. Vents/Cabin Air/Heat -- OPEN when it is ascertained that fire is completely extinguished.

CABIN FIRE

1. Master Switch -- OFF.
2. Vents/Cabin Air/Heat -- CLOSED (to avoid drafts).
3. Fire Extinguisher -- ACTIVATE (if available).

WARNING

After discharging an extinguisher within a closed cabin, ventilate the cabin.

4. Land the airplane as soon as possible to inspect for damage.

WING FIRE

1. Navigation Light Switch -- OFF.
2. Pitot Heat Switch (if installed) -- OFF.
3. Strobe Light Switch (if installed) -- OFF.

NOTE

Perform a sideslip to keep the flames away from the fuel tank and cabin, and land as soon as possible using flaps only as required for final approach and touchdown.

ICING

INADVERTENT ICING ENCOUNTER

1. Turn pitot heat switch ON (if installed).
2. Turn back or change altitude to obtain an outside air temperature that is less conducive to icing.
3. Pull cabin heat control full out and open defroster outlets to obtain maximum windshield defroster airflow. Adjust cabin air control to get maximum defroster heat and airflow.
4. Open the throttle to increase engine speed and minimize ice build-up on propeller blades.
5. Watch for signs of carburetor air filter ice and apply carburetor

heat as required. An unexplained loss in engine speed could be caused by carburetor ice or air intake filter ice. Lean the mixture for maximum RPM, if carburetor heat is used continuously.

6. Plan a landing at the nearest airport. With an extremely rapid ice build-up, select a suitable "off airport" landing site.
7. With an ice accumulation of 1/4 inch or more on the wing leading edges, be prepared for significantly higher stall speed.
8. Leave wing flaps retracted. With a severe ice build-up on the horizontal tail, the change in wing wake airflow direction caused by wing flap extension could result in a loss of elevator effectiveness.
9. Open left window and, if practical, scrape ice from a portion of the windshield for visibility in the landing approach.
10. Perform a landing approach using a forward slip, if necessary, for improved visibility.
11. Approach at 65 to 75 KIAS depending upon the amount of the accumulation.
12. Perform a landing in level attitude.

STATIC SOURCE BLOCKAGE (Erroneous Instrument Reading Suspected)

1. Alternate Static Source Valve -- PULL ON.
2. Airspeed -- Consult appropriate calibration tables in Section 5.

LANDING WITH A FLAT MAIN TIRE

1. Approach -- NORMAL.
2. Touchdown -- GOOD TIRE FIRST, hold airplane off flat tire as long as possible.

ELECTRICAL POWER SUPPLY SYSTEM MALFUNCTIONS

AMMETER SHOWS EXCESSIVE RATE OF CHARGE (Full Scale Deflection)

1. Alternator -- OFF.
2. Alternator Circuit Breaker -- PULL.
3. Nonessential Electrical Equipment -- OFF.
4. Flight -- TERMINATE as soon as practical.

**LOW-VOLTAGE LIGHT ILLUMINATES DURING FLIGHT
(Ammeter Indicates Discharge)**

NOTE

Illumination of the low-voltage light may occur during low RPM conditions with an electrical load on the system such as during a low RPM taxi. Under these conditions, the light will go out at higher RPM. The master switch need not be recycled since an over-voltage condition has not occurred to de-activate the alternator system.

1. Avionics Power Switch -- OFF.
2. Alternator Circuit Breaker -- CHECK IN.
3. Master Switch -- OFF (both sides).
4. Master Switch -- ON.
5. **Low-Voltage Light** -- CHECK OFF.
6. Avionics Power Switch -- ON.

If low-voltage light illuminates again:

7. Alternator -- OFF.
8. Nonessential Radio and Electrical Equipment -- OFF.
9. Flight -- TERMINATE as soon as practical.

AMPLIFIED PROCEDURES

ENGINE FAILURE

If an engine failure occurs during the takeoff run, the most important thing to do is stop the airplane on the remaining runway. Those extra items on the checklist will provide added safety after a failure of this type.

Prompt lowering of the nose to maintain airspeed and establish a glide attitude is the first response to an engine failure after takeoff. In most cases, the landing should be planned straight ahead with only small changes in direction to avoid obstructions. Altitude and airspeed are seldom sufficient to execute a 180° gliding turn necessary to return to the runway. The checklist procedures assume that adequate time exists to secure the fuel and ignition systems prior to touchdown.

After an engine failure in flight, the best glide speed as shown in figure 3-1 should be established as quickly as possible. While gliding toward a suitable landing area, an effort should be made to identify the cause of the failure. If time permits, an engine restart should be attempted as shown in the checklist. If the engine cannot be restarted, a forced landing without power must be completed.

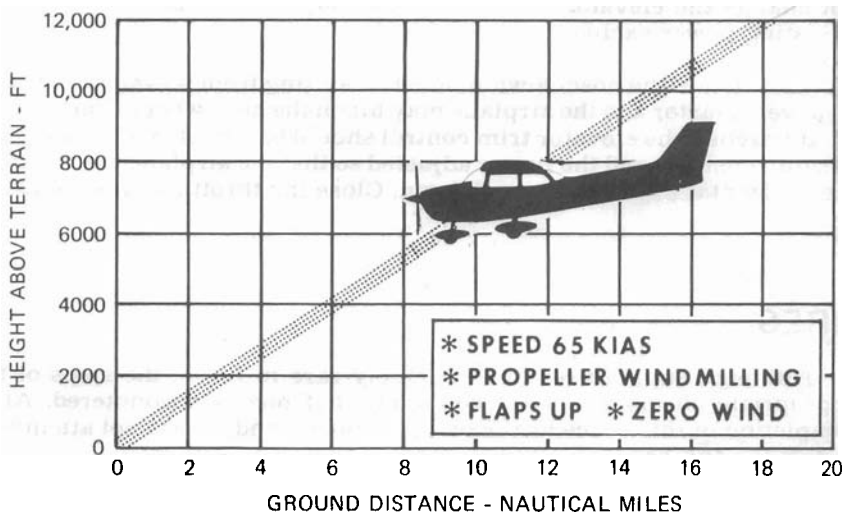

Figure 3-1. Maximum Glide

FORCED LANDINGS

If all attempts to restart the engine fail and a forced landing is imminent, select a suitable field and prepare for the landing as discussed under the Emergency Landing Without Engine Power checklist.

Before attempting an "off airport" landing with engine power available, one should fly over the landing area at a safe but low altitude to inspect the terrain for obstructions and surface conditions, proceeding as discussed under the Precautionary Landing With Engine Power checklist.

Prepare for ditching by securing or jettisoning heavy objects located in the baggage area and collect folded coats for protection of occupants' face at touchdown. Transmit Mayday message on 121.5 MHz giving location and intentions and squawk 7700 if a transponder is installed. Avoid a landing flare because of difficulty in judging height over a water surface.

LANDING WITHOUT ELEVATOR CONTROL

Trim for horizontal flight (with an airspeed of approximately 60 KIAS and flaps set to 20°) by using throttle and elevator trim controls. Then **do not change the elevator trim control setting**; control the glide angle by adjusting power exclusively.

At flareout, the nose-down moment resulting from power reduction is an adverse factor and the airplane may hit on the nose wheel. Consequently, at flareout, the elevator trim control should be adjusted toward the full nose-up position and the power adjusted so that the airplane will rotate to the horizontal attitude for touchdown. Close the throttle at touchdown.

FIRES

Although engine fires are extremely rare in flight, the steps of the appropriate checklist should be followed if one is encountered. After completion of this procedure, execute a forced landing. Do not attempt to restart the engine.

The initial indication of an electrical fire is usually the odor of burning insulation. The checklist for this problem should result in elimination of the fire.

EMERGENCY OPERATION IN CLOUDS (Vacuum System Failure)

In the event of a vacuum system failure during flight, the directional indicator and attitude indicator will be disabled, and the pilot will have to rely on the turn coordinator if he inadvertently flies into clouds. The following instructions assume that only the electrically-powered turn coordinator is operative, and that the pilot is not completely proficient in instrument flying.

EXECUTING A 180° TURN IN CLOUDS

Upon inadvertently entering the clouds, an immediate plan should be made to turn back as follows:

1. Note the compass heading.
2. **Note the time of the minute hand** and observe the position of the sweep second hand on the clock.
3. When the sweep second hand indicates the nearest half-minute, initiate a standard rate left turn, holding the turn coordinator symbolic airplane wing opposite the lower left index mark for 60 seconds. Then roll back to level flight by leveling the miniature airplane.
4. Check accuracy of the turn by observing the compass heading which should be the reciprocal of the original heading.
5. If necessary, adjust heading primarily with skidding motions rather than rolling motions so that the compass will read more accurately.
6. Maintain altitude and airspeed by cautious application of elevator control. Avoid overcontrolling by keeping the hands off the control wheel as much as possible and steering only with rudder.

EMERGENCY DESCENT THROUGH CLOUDS

If conditions preclude reestablishment of VFR flight by a 180° turn, a descent through a cloud deck to VFR conditions may be appropriate. If possible, obtain radio clearance for an emergency descent through clouds. To guard against a spiral dive, choose an easterly or westerly heading to minimize compass card swings due to changing bank angles. In addition, keep hands off the control wheel and steer a straight course with rudder control by monitoring the turn coordinator. Occasionally check the compass heading and make minor corrections to hold an approximate course. Before descending into the clouds, set up a stabilized let-down condition as follows:

1. Apply full rich mixture.
2. Use full carburetor heat.
3. Reduce power to set up a 500 to 800 ft/min rate of descent.
4. Adjust the elevator trim and rudder trim (if installed) for a stabilized descent at 70-80 KIAS.
5. Keep hands off the control wheel.
6. Monitor turn coordinator and make corrections by rudder alone.
7. Check trend of compass card movement and make cautious corrections with rudder to stop the turn.
8. Upon breaking out of clouds, resume normal cruising flight.

RECOVERY FROM A SPIRAL DIVE

If a spiral is encountered, proceed as follows:

1. Close the throttle.
2. Stop the turn by using coordinated aileron and rudder control to align the symbolic airplane in the turn coordinator with the horizon reference line.
3. Cautiously apply elevator back pressure to slowly reduce the airspeed to 80 KIAS.
4. Adjust the elevator trim control to maintain an 80 KIAS glide.
5. Keep hands off the control wheel, using rudder control to hold a straight heading. Adjust rudder trim (if installed) to relieve unbalanced rudder force.
6. Apply carburetor heat.
7. Clear engine occasionally, but avoid using enough power to disturb the trimmed glide.
8. Upon breaking out of clouds, resume normal cruising flight.

INADVERTENT FLIGHT INTO ICING CONDITIONS

Flight into icing conditions is prohibited. An inadvertent encounter with these conditions can best be handled using the checklist procedures. The best procedure, of course, is to turn back or change altitude to escape icing conditions.

STATIC SOURCE BLOCKED

If erroneous readings of the static source instruments (airspeed, altimeter and rate-of-climb) are suspected, the alternate static source valve should be pulled on, thereby supplying static pressure to these instruments from the cabin.

NOTE

In an emergency on airplanes not equipped with an alternate static source, cabin pressure can be supplied to the static pressure instruments by breaking the glass in the face of the rate-of-climb indicator.

With the alternate static source on, adjust indicated airspeed slightly during climb or approach according to the alternate static source airspeed calibration table in Section 5, appropriate to vent/window(s) configuration, causing the airplane to be flown at the normal operating speeds.

Maximum airspeed and altimeter variation from normal is 4 knots and 30 feet over the normal operating range with the window(s) closed. With window(s) open, larger variations occur near stall speed. However, maximum altimeter variation remains within 50 feet of normal.

SPINS

Should an inadvertent spin occur, the following recovery procedure should be used:

1. RETARD THROTTLE TO IDLE POSITION.
2. PLACE AILERONS IN NEUTRAL POSITION.
3. APPLY AND **HOLD** FULL RUDDER OPPOSITE TO THE DIRECTION OF ROTATION.
4. JUST **AFTER** THE RUDDER REACHES THE STOP, MOVE THE CONTROL WHEEL **BRISKLY** FORWARD FAR ENOUGH TO BREAK THE STALL. Full down elevator may be required at aft center of gravity loadings to assure optimum recoveries.
5. **HOLD** THESE CONTROL INPUTS UNTIL ROTATION STOPS. Premature relaxation of the control inputs may extend the recovery.
6. AS ROTATION STOPS, NEUTRALIZE RUDDER, AND MAKE A SMOOTH RECOVERY FROM THE RESULTING DIVE.

NOTE

If disorientation precludes a visual determination of the direction of rotation, the symbolic airplane in the turn coordinator may be referred to for this information.

For additional information on spins and spin recovery, see the discussion under SPINS in Normal Procedures (Section 4).

ROUGH ENGINE OPERATION OR LOSS OF POWER

CARBURETOR ICING

A gradual loss of RPM and eventual engine roughness may result from the formation of carburetor ice. To clear the ice, apply full throttle and pull the carburetor heat knob full out until the engine runs smoothly; then remove carburetor heat and readjust the throttle. If conditions require the continued use of carburetor heat in cruise flight, use the minimum amount of heat necessary to prevent ice from forming and lean the mixture for smoothest engine operation.

SPARK PLUG FOULING

A slight engine roughness in flight may be caused by one or more spark plugs becoming fouled by carbon or lead deposits. This may be verified by turning the ignition switch momentarily from BOTH to either L or R position. An obvious power loss in single ignition operation is evidence of spark plug or magneto trouble. Assuming that spark plugs are the more likely cause, lean the mixture to the recommended lean setting for cruising flight. If the problem does not clear up in several minutes, determine if a richer mixture setting will produce smoother operation. If not, proceed to the nearest airport for repairs using the BOTH position of the ignition switch unless extreme roughness dictates the use of a single ignition position.

MAGNETO MALFUNCTION

A sudden engine roughness or misfiring is usually evidence of magneto problems. Switching from BOTH to either L or R ignition switch position will identify which magneto is malfunctioning. Select different power settings and enrichen the mixture to determine if continued operation on BOTH magnetos is practicable. If not, switch to the good magneto and proceed to the nearest airport for repairs.

LOW OIL PRESSURE

If low oil pressure is accompanied by normal oil temperature, there is a possibility the oil pressure gage or relief valve is malfunctioning. A leak in the line to the gage is not necessarily cause for an immediate precautionary landing because an orifice in this line will prevent a sudden loss of oil from the engine sump. However, a landing at the nearest airport would be advisable to inspect the source of trouble.

If a total loss of oil pressure is accompanied by a rise in oil temperature, there is good reason to suspect an engine failure is imminent. Reduce

engine power immediately and select a suitable forced landing field. Use only the minimum power required to reach the desired touchdown spot.

ELECTRICAL POWER SUPPLY SYSTEM MALFUNCTIONS

Malfunctions in the electrical power supply system can be detected by periodic monitoring of the ammeter and low-voltage warning light; however, the cause of these malfunctions is usually difficult to determine. A broken alternator drive belt or wiring is most likely the cause of alternator failures, although other factors could cause the problem. A damaged or improperly adjusted alternator control unit can also cause malfunctions. Problems of this nature constitute an electrical emergency and should be dealt with immediately. Electrical power malfunctions usually fall into two categories: excessive rate of charge and insufficient rate of charge. The following paragraphs describe the recommended remedy for each situation.

EXCESSIVE RATE OF CHARGE

After engine starting and heavy electrical usage at low engine speeds (such as extended taxiing) the battery condition will be low enough to accept above normal charging during the initial part of a flight. However, after thirty minutes of cruising flight, the ammeter should be indicating less than two needle widths of charging current. If the charging rate were to remain above this value on a long flight, the battery would overheat and evaporate the electrolyte at an excessive rate.

Electronic components in the electrical system can be adversely affected by higher than normal voltage. The alternator control unit includes an over-voltage sensor which normally will automatically shut down the alternator if the charge voltage reaches approximately 31.5 volts. If the over-voltage sensor malfunctions or is improperly adjusted, as evidenced by an excessive rate of charge shown on the ammeter, the alternator should be turned off, alternator circuit breaker pulled, non-essential electrical equipment turned off and the flight terminated as soon as practical.

INSUFFICIENT RATE OF CHARGE

NOTE

Illumination of the low-voltage light and ammeter discharge indications may occur during low RPM conditions with an electrical load on the system, such as during a low

RPM taxi. Under these conditions, the light will go out at higher RPM. The master switch need not be recycled since an over-voltage condition has not occurred to de-activate the alternator system.

If the over-voltage sensor should shut down the alternator, or if the alternator circuit breaker should trip, a discharge rate will be shown on the ammeter followed by illumination of the low-voltage warning light. Since this may be a "nuisance" trip-out, an attempt should be made to reactivate the alternator system. To do this, turn the avionics power switch off, check that the alternator circuit breaker is in, then turn both sides of the master switch off and then on again. If the problem no longer exists, normal alternator charging will resume and the low-voltage light will go off. The avionics power switch may then be turned back on. If the light illuminates again, a malfunction is confirmed. In this event, the flight should be terminated and/or the current drain on the battery minimized because the battery can supply the electrical system for only a limited period of time. If the emergency occurs at night, power must be conserved for later use of the landing lights and flaps during landing.

SECTION 4

NORMAL PROCEDURES

TABLE OF CONTENTS

	Page
Introduction	4-3
Speeds For Normal Operation	4-3

CHECKLIST PROCEDURES

Preflight Inspection	4-5
Cabin	4-5
Empennage	4-5
Right Wing, Trailing Edge	4-5
Right Wing	4-5
Nose	4-6
Left Wing	4-6
Left Wing, Leading Edge	4-6
Left Wing, Trailing Edge	4-6
Before Starting Engine	4-6
Starting Engine	4-7
Before Takeoff	4-7
Takeoff	4-8
Normal Takeoff	4-8
Short Field Takeoff	4-8
Enroute Climb	4-8
Cruise	4-9
Descent	4-9
Before Landing	4-9
Landing	4-9
Normal Landing	4-9
Short Field Landing	4-9
Balked Landing	4-10
After Landing	4-10
Securing Airplane	4-10

AMPLIFIED PROCEDURES

Starting Engine	4-11
Taxiing	4-11

TABLE OF CONTENTS (Continued)

	Page
Before Takeoff	4-13
Warm-Up	4-13
Magnetos Check	4-13
Alternator Check	4-13
Takeoff	4-13
Power Check	4-13
Wing Flap Settings	4-14
Crosswind Takeoff	4-15
Enroute Climb	4-15
Cruise	4-15
Leaning With A Cessna Economy Mixture Indicator (EGT).	4-17
Stalls	4-17
Spins	4-17
Landing	4-19
Normal Landing	4-19
Short Field Landing	4-20
Crosswind Landing	4-20
Balked Landing	4-20
Cold Weather Operation	4-21
Starting	4-21
Flight Operations	4-23
Hot Weather Operation	4-23
Noise Abatement	4-23

INTRODUCTION

Section 4 provides checklist and amplified procedures for the conduct of normal operation. Normal procedures associated with optional systems can be found in Section 9.

SPEEDS FOR NORMAL OPERATION

Unless otherwise noted, the following speeds are based on a maximum weight of 2300 pounds and may be used for any lesser weight. However, to achieve the performance specified in Section 5 for takeoff distance, the speed appropriate to the particular weight must be used.

Takeoff, Flaps Up:

Normal Climb Out	70-80 KIAS
Short Field Takeoff, Flaps 10°, Speed at 50 Feet	53 KIAS

Enroute Climb, Flaps Up:

Normal, Sea Level	75-85 KIAS
Normal, 10,000 Feet	70-80 KIAS
Best Rate of Climb, Sea Level	73 KIAS
Best Rate of Climb, 10,000 Feet	68 KIAS
Best Angle of Climb, Sea Level	59 KIAS
Best Angle of Climb, 10,000 Feet,	61 KIAS

Landing Approach:

Normal Approach, Flaps Up	60-70 KIAS
Normal Approach, Flaps 40°	55-65 KIAS
Short Field Approach, Flaps 40°	59 KIAS

Balked Landing:

Maximum Power, Flaps 20°	55 KIAS
------------------------------------	---------

Maximum Recommended Turbulent Air Penetration Speed:

2300 Lbs	97 KIAS
1950 Lbs	89 KIAS
1600 Lbs	80 KIAS

Maximum Demonstrated Crosswind Velocity:

Takeoff or Landing	15 KNOTS
------------------------------	----------

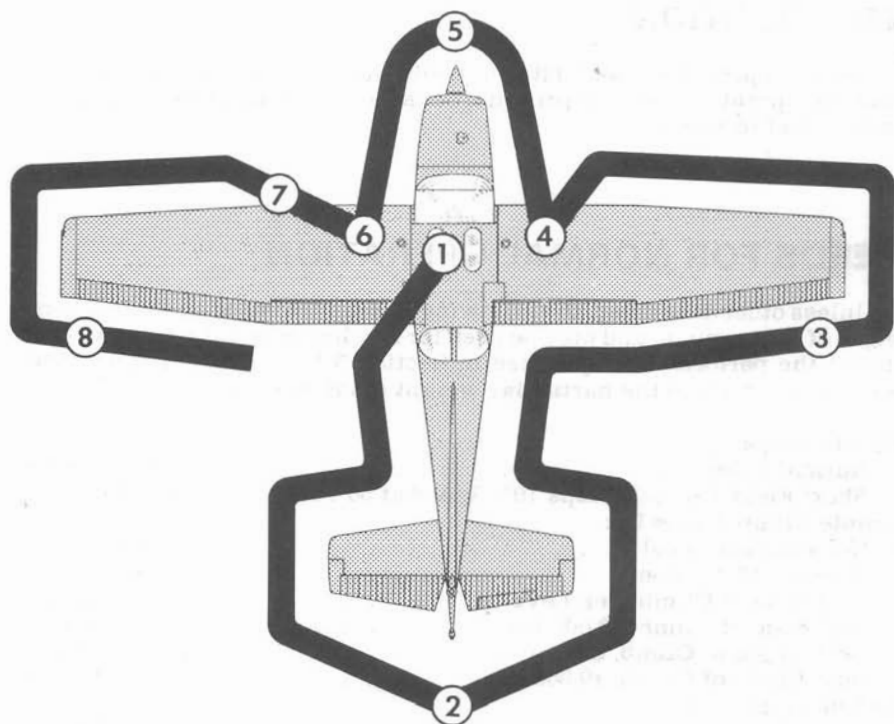

NOTE

Visually check airplane for general condition during walk-around inspection. In cold weather, remove even small accumulations of frost, ice or snow from wing, tail and control surfaces. Also, make sure that control surfaces contain no internal accumulations of ice or debris. Prior to flight, check that pitot heater (if installed) is warm to touch within 30 seconds with battery and pitot heat switches on. If a night flight is planned, check operation of all lights, and make sure a flashlight is available.

Figure 4-1. Preflight Inspection

CHECKLIST PROCEDURES

PREFLIGHT INSPECTION

① CABIN

1. Pilot's Operating Handbook -- AVAILABLE IN THE AIRPLANE.
2. Control Wheel Lock -- REMOVE.
3. Ignition Switch -- OFF.
4. Avionics Power Switch -- OFF.
5. Master Switch -- ON.

WARNING

When turning on the master switch, using an external power source, or pulling the propeller through by hand, treat the propeller as if the ignition switch were on. Do not stand, nor allow anyone else to stand, within the arc of the propeller, since a loose or broken wire, or a component malfunction, could cause the propeller to rotate.

6. Fuel Quantity Indicators -- CHECK QUANTITY.
7. Master Switch -- OFF.
8. Static Pressure Alternate Source Valve (if installed) -- OFF.
9. Baggage Door -- CHECK, lock with key if child's seat is to be occupied.

② EMPENNAGE

1. Rudder Gust Lock -- REMOVE.
2. Tail Tie-Down -- DISCONNECT.
3. Control Surfaces -- CHECK freedom of movement and security.

③ RIGHT WING Trailing Edge

1. Aileron -- CHECK freedom of movement and security.

④ RIGHT WING

1. Wing Tie-Down -- DISCONNECT.
2. Main Wheel Tire -- CHECK for proper inflation.
3. Before first flight of the day and after each refueling, use sampler cup and drain small quantity of fuel from fuel tank sump quick-drain valve to check for water, sediment, and proper fuel grade.
4. Fuel Quantity -- CHECK VISUALLY for desired level.
5. Fuel Filler Cap -- SECURE.

5 NOSE

1. Engine Oil Level -- CHECK, do not operate with less than four quarts. Fill to six quarts for extended flight.
2. Before first flight of the day and after each refueling, pull out strainer drain knob for about four seconds to clear fuel strainer of possible water and sediment. Check strainer drain closed. If water is observed, the fuel system may contain additional water, and further draining of the system at the strainer, fuel tank sumps, and fuel selector valve drain plug will be necessary.
3. Propeller and Spinner -- CHECK for nicks and security.
4. Landing Light(s) -- CHECK for condition and cleanliness.
5. Carburetor Air Filter -- CHECK for restrictions by dust or other foreign matter.
6. Nose Wheel Strut and Tire -- CHECK for proper inflation.
7. Nose Tie-Down -- DISCONNECT.
8. Static Source Opening (left side of fuselage) -- CHECK for stoppage.

6 LEFT WING

1. Main Wheel Tire -- CHECK for proper inflation.
2. Before first flight of the day and after each refueling, use sampler cup and drain small quantity of fuel from fuel tank sump quick-drain valve to check for water, sediment and proper fuel grade.
3. Fuel Quantity -- CHECK VISUALLY for desired level.
4. Fuel Filler Cap -- SECURE.

7 LEFT WING Leading Edge

1. Pitot Tube Cover -- REMOVE and check opening for stoppage.
2. Fuel Tank Vent Opening -- CHECK for stoppage.
3. Stall Warning Opening -- CHECK for stoppage. To check the system, place a clean handkerchief over the vent opening and apply suction; a sound from the warning horn will confirm system operation.
4. Wing Tie-Down -- DISCONNECT.

8 LEFT WING Trailing Edge

1. Aileron -- CHECK for freedom of movement and security.

BEFORE STARTING ENGINE

1. Preflight Inspection -- COMPLETE.

2. Seats, Belts, Shoulder Harnesses -- ADJUST and LOCK.
3. Fuel Selector Valve -- BOTH.
4. Avionics Power Switch, Autopilot (if installed), Electrical Equipment -- OFF.

CAUTION

The avionics power switch must be OFF during engine start to prevent possible damage to avionics.

5. Brakes -- TEST and SET.
6. Circuit Breakers -- CHECK IN.

STARTING ENGINE

1. Mixture -- RICH.
2. Carburetor Heat -- COLD.
3. Master Switch -- ON.
4. Prime -- AS REQUIRED (2 to 6 strokes; none if engine is warm).
5. Throttle -- OPEN 1/8 INCH.
6. Propeller Area -- CLEAR.
7. Ignition Switch -- START (release when engine starts).
8. Oil Pressure -- CHECK.
9. Flashing Beacon and Navigation Lights -- ON as required.
10. Avionics Power Switch -- ON.
11. Radios -- ON.

BEFORE TAKEOFF

1. Parking Brake -- SET.
2. Cabin Doors and Window(s) -- CLOSED and LOCKED.
3. Flight Controls -- FREE and CORRECT.
4. Flight Instruments -- SET.
5. Fuel Selector Valve -- BOTH.
6. Mixture -- RICH (below 3000 feet).
7. Elevator Trim and Rudder Trim (if installed) -- TAKEOFF.
8. Throttle -- 1700 RPM.
 - a. **Magnetos -- CHECK (RPM drop should not exceed 125 RPM on either magneto or 50 RPM differential between magnetos).**
 - b. Carburetor Heat -- CHECK (for RPM drop).
 - c. Engine Instruments and Ammeter -- CHECK.
 - d. Suction Gage -- CHECK.
 - e. Throttle -- 1000 RPM or LESS.

9. Radios -- SET.
10. Autopilot (if installed) -- OFF.
11. Air Conditioner (if installed) -- OFF.
12. Strobe Lights -- AS DESIRED.
13. Throttle Friction Lock -- ADJUST.
14. Brakes -- RELEASE.

TAKEOFF

NORMAL TAKEOFF

1. Wing Flaps -- 0° - 10°.
2. Carburetor Heat -- COLD.
3. Throttle -- FULL OPEN.
4. Elevator Control -- LIFT NOSE WHEEL (at 55 KIAS).
5. Climb Speed -- 70-80 KIAS.

SHORT FIELD TAKEOFF

1. Wing Flaps -- 10°.
2. Carburetor Heat -- COLD.
3. Brakes -- APPLY.
4. Throttle -- FULL OPEN.
5. Mixture -- RICH (above 3000 feet, LEAN to obtain maximum RPM).
6. Brakes -- RELEASE.
7. Elevator Control -- SLIGHTLY TAIL LOW.
8. Climb Speed -- 53 KIAS (until all obstacles are cleared).

ENROUTE CLIMB

1. Airspeed -- 70-85 KIAS.

NOTE

If a maximum performance climb is necessary, use speeds shown in the Rate Of Climb chart in Section 5.

2. Throttle -- FULL OPEN.
3. Mixture -- RICH (above 3000 feet, LEAN to obtain maximum RPM).

CRUISE

1. Power -- 2200-2700 RPM (no more than 75% is recommended).
2. Elevator and Rudder Trim (if installed) -- ADJUST.
3. Mixture -- LEAN.

DESCENT

1. Fuel Selector Valve -- BOTH.
2. Mixture -- ADJUST for smooth operation (full rich for idle power).
3. Power -- AS DESIRED.
4. Carburetor Heat -- FULL HEAT AS REQUIRED (to prevent carburetor icing).

BEFORE LANDING

1. Seats, Belts, Harnesses -- SECURE.
2. Fuel Selector Valve -- BOTH.
3. Mixture -- RICH.
4. Carburetor Heat -- ON (apply full heat before reducing power).
5. Autopilot (if installed) -- OFF.
6. Air Conditioner (if installed) -- OFF.

LANDING

NORMAL LANDING

1. Airspeed -- 60-70 KIAS (flaps UP).
2. Wing Flaps -- AS DESIRED (0°-10° below 110 KIAS, 10°-40° below 85 KIAS).
3. Airspeed -- 55-65 KIAS (flaps DOWN).
4. Touchdown -- MAIN WHEELS FIRST.
5. Landing Roll -- LOWER NOSE WHEEL GENTLY.
6. Braking -- MINIMUM REQUIRED.

SHORT FIELD LANDING

1. Airspeed -- 60-70 KIAS (flaps UP).
2. Wing Flaps -- FULL DOWN (40°).
3. Airspeed -- 59 KIAS (until flare).
4. Power -- REDUCE to idle after clearing obstacle.
5. Touchdown -- MAIN WHEELS FIRST.
6. Brakes -- APPLY HEAVILY.
7. Wing Flaps -- RETRACT.

BALKED LANDING

1. Throttle -- FULL OPEN.
2. Carburetor Heat -- COLD.
3. Wing Flaps -- 20° (immediately).
4. Climb Speed -- 55 KIAS.
5. Wing Flaps -- 10° (until obstacles are cleared).
RETRACT (after reaching a safe altitude and 60 KIAS).

AFTER LANDING

1. Wing Flaps -- UP.
2. Carburetor Heat -- COLD.

SECURING AIRPLANE

1. Parking Brake -- SET.
2. Avionics Power Switch, Electrical Equipment, Autopilot (if installed) -- OFF.
3. Mixture -- IDLE CUT-OFF (pulled full out).
4. Ignition Switch -- OFF.
5. Master Switch -- OFF.
6. Control Lock -- INSTALL.

AMPLIFIED PROCEDURES

STARTING ENGINE

During engine starting, open the throttle approximately 1/8 inch. In warm temperatures, one or two strokes of the primer should be sufficient. In cold weather, up to six strokes of the primer may be necessary. If the engine is warm, no priming will be required. In extremely cold temperatures, it may be necessary to continue priming while cranking the engine.

Weak intermittent firing followed by puffs of black smoke from the exhaust stack indicates overpriming or flooding. Excess fuel can be cleared from the combustion chambers by the following procedure: set the mixture control full lean and the throttle full open; then crank the engine through several revolutions with the starter. Repeat the starting procedure without any additional priming.

If the engine is underprimed (most likely in cold weather with a cold engine) it will not fire at all, and additional priming will be necessary. As soon as the cylinders begin to fire, open the throttle slightly to keep it running.

After starting, if the oil gage does not begin to show pressure within 30 seconds in the summertime and about twice that long in very cold weather, stop engine and investigate. Lack of oil pressure can cause serious engine damage. After starting, avoid the use of carburetor heat unless icing conditions prevail.

NOTE

Additional details concerning cold weather starting and operation may be found under COLD WEATHER OPERATION paragraphs in this section.

TAXIING

When taxiing, it is important that speed and use of brakes be held to a minimum and that all controls be utilized (see Taxiing Diagram, figure 4-2) to maintain directional control and balance.

The carburetor heat control knob should be pushed full in during all ground operations unless heat is absolutely necessary. When the knob is pulled out to the heat position, air entering the engine is not filtered.

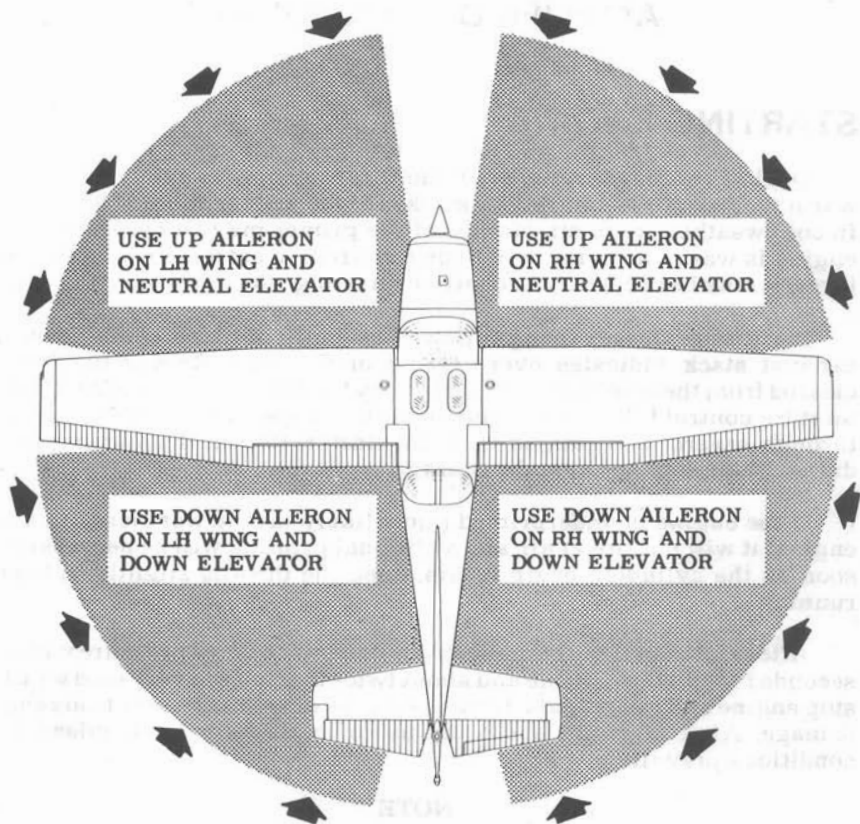

CODE

NOTE

WIND DIRECTION →

Strong quartering tail winds require caution. Avoid sudden bursts of the throttle and sharp braking when the airplane is in this attitude. Use the steerable nose wheel and rudder to maintain direction.

Figure 4-2. Taxiing Diagram

Taxiing over loose gravel or cinders should be done at low engine speed to avoid abrasion and stone damage to the propeller tips.

BEFORE TAKEOFF

WARM-UP

If the engine accelerates smoothly, the airplane is ready for takeoff. Since the engine is closely cowled for efficient in-flight engine cooling, precautions should be taken to avoid overheating during prolonged engine operation on the ground. Also, long periods of idling may cause fouled spark plugs.

MAGNETO CHECK

The magneto check should be made at 1700 RPM as follows. Move ignition switch first to R position and note RPM. Next move switch back to BOTH to clear the other set of plugs. Then move switch to the L position, note RPM and return the switch to the BOTH position. RPM drop should not exceed 125 RPM on either magneto or show greater than 50 RPM differential between magnetos. If there is a doubt concerning operation of the ignition system, RPM checks at higher engine speeds will usually confirm whether a deficiency exists.

An absence of RPM drop may be an indication of faulty grounding of one side of the ignition system or should be cause for suspicion that the magneto timing is set in advance of the setting specified.

ALTERNATOR CHECK

Prior to flights where verification of proper alternator and alternator control unit operation is essential (such as night or instrument flights), a positive verification can be made by loading the electrical system momentarily (3 to 5 seconds) with the landing light or by operating the wing flaps during the engine runup (1700 RPM). The ammeter will remain within a needle width of its initial reading if the alternator and alternator control unit are operating properly.

TAKEOFF

POWER CHECK

It is important to check full-throttle engine operation early in the

takeoff run. Any sign of rough engine operation or sluggish engine acceleration is good cause for discontinuing the takeoff. If this occurs, you are justified in making a thorough full-throttle static runup before another takeoff is attempted. The engine should run smoothly and turn approximately 2280 to 2400 RPM with carburetor heat off and mixture full rich.

NOTE

Carburetor heat should not be used during takeoff unless it is absolutely necessary for obtaining smooth engine acceleration.

Full-throttle runups over loose gravel are especially harmful to propeller tips. When takeoffs must be made over a gravel surface, it is very important that the throttle be advanced slowly. This allows the airplane to start rolling before high RPM is developed, and the gravel will be blown back of the propeller rather than pulled into it. When unavoidable small dents appear in the propeller blades, they should be immediately corrected as described in Section 8 under Propeller Care.

Prior to takeoff from fields above 3000 feet elevation, the mixture should be leaned to give maximum RPM in a full-throttle, static runup.

After full throttle is applied, adjust the throttle friction lock clockwise to prevent the throttle from creeping back from a maximum power position. Similar friction lock adjustments should be made as required in other flight conditions to maintain a fixed throttle setting.

WING FLAP SETTINGS

Normal takeoffs are accomplished with wing flaps 0° - 10°. Using 10° wing flaps reduces the ground roll and total distance over an obstacle by approximately 5 percent. Flap deflections greater than 10° are not approved for takeoff. If 10° wing flaps are used for takeoff, they should be left down until all obstacles are cleared and a safe flap retraction speed of 60 KIAS is reached. On a short field, 10° wing flaps and an obstacle clearance speed of 53 KIAS should be used.

Soft or rough field takeoffs are performed with 10° flaps by lifting the airplane off the ground as soon as practical in a slightly tail-low attitude. If no obstacles are ahead, the airplane should be leveled off immediately to accelerate to a higher climb speed. When departing a soft field with an aft C.G. loading, the elevator trim should be adjusted towards the nose down direction to give comfortable control wheel forces during the initial climb.

CROSSWIND TAKEOFF

Takeoffs into strong crosswinds normally are performed with the minimum flap setting necessary for the field length, to minimize the drift angle immediately after takeoff. With the ailerons partially deflected into the wind, the airplane is accelerated to a speed slightly higher than normal, then pulled off abruptly to prevent possible settling back to the runway while drifting. When clear of the ground, make a coordinated turn into the wind to correct for drift.

ENROUTE CLIMB

Normal climbs are performed with flaps up and full throttle and at speeds 5 to 10 knots higher than best rate-of-climb speeds for the best combination of performance, visibility and engine cooling. The mixture should be full rich below 3000 feet and may be leaned above 3000 feet for smoother operation or to obtain maximum RPM. For maximum rate of climb, use the best rate-of-climb speeds shown in the Rate-of-Climb chart in Section 5. If an obstruction dictates the use of a steep climb angle, the best angle-of-climb speed should be used with flaps up and maximum power. Climbs at speeds lower than the best rate-of-climb speed should be of short duration to improve engine cooling.

CRUISE

Normal cruising is performed between 55% and 75% power. The engine RPM and corresponding fuel consumption for various altitudes can be determined by using your Cessna Power Computer or the data in Section 5.

NOTE

Cruising should be done at a minimum of 75% power until a total of 25 hours has accumulated or oil consumption has stabilized. Operation at this higher power will ensure proper seating of the rings and is applicable to new engines, and engines in service following cylinder replacement or top overhaul of one or more cylinders.

The Cruise Performance Table, figure 4-3, illustrates the true airspeed and nautical miles per gallon during cruise for various altitudes and percent powers. This table should be used as a guide, along with the available winds aloft information, to determine the most favorable altitude and power setting for a given trip. The selection of cruise altitude on the basis of the most favorable wind conditions and the use of low power settings are significant factors that should be considered on every trip to reduce fuel consumption.

To achieve the recommended lean mixture fuel consumption figures shown in Section 5, the mixture should be leaned until engine RPM peaks and drops 25-50 RPM. At lower powers it may be necessary to enrichen the mixture slightly to obtain smooth operation.

Should it be necessary to cruise at higher than 75% power, the mixture should not be leaned more than is required to provide peak RPM.

Carburetor ice, as evidenced by an unexplained drop in RPM, can be removed by application of full carburetor heat. Upon regaining the original RPM (with heat off), use the minimum amount of heat (by trial and error) to prevent ice from forming. Since the heated air causes a richer mixture, readjust the mixture setting when carburetor heat is to be used continuously in cruise flight.

The use of full carburetor heat is recommended during flight in heavy rain to avoid the possibility of engine stoppage due to excessive water ingestion or carburetor ice. The mixture setting should be readjusted for smoothest operation. Power changes should be made cautiously, followed by prompt adjustment of the mixture for smoothest operation.

ALTITUDE	75% POWER		65% POWER		55% POWER	
	KTAS	NMPG	KTAS	NMPG	KTAS	NMPG
Sea Level	114	13.5	107	14.8	100	16.1
4000 Feet	118	14.0	111	15.3	103	16.6
8000 Feet	122	14.5	115	15.8	106	17.1
Standard Conditions					Zero Wind	

Figure 4-3. Cruise Performance Table

MIXTURE DESCRIPTION	EXHAUST GAS TEMPERATURE
RECOMMENDED LEAN (Pilot's Operating Handbook and Power Computer)	50 ^o F Rich of Peak EGT
BEST ECONOMY	Peak EGT

Figure 4-4. EGT Table

LEANING WITH A CESSNA ECONOMY MIXTURE INDICATOR (EGT)

Exhaust gas temperature (EGT) as shown on the optional Cessna Economy Mixture Indicator may be used as an aid for mixture leaning in cruising flight at 75% power or less. To adjust the mixture, using this indicator, lean to establish the peak EGT as a reference point and then enrichen the mixture by the desired increment based on figure 4-4.

As noted in this table, operation at peak EGT provides the best fuel economy. This results in approximately 4% greater range than shown in this handbook accompanied by approximately a 3 knot decrease in speed.

Under some conditions, engine roughness may occur while operating at peak EGT. In this case, operate at the Recommended Lean mixture. Any change in altitude or throttle position will require a recheck of EGT indication.

STALLS

The stall characteristics are conventional and aural warning is provided by a stall warning horn which sounds between 5 and 10 knots above the stall in all configurations.

Power-off stall speeds at maximum weight for both forward and aft C.G. positions are presented in Section 5.

SPINS

Intentional spins are approved in this airplane within certain restrict-

ed loadings. Spins with baggage loadings or occupied rear seat(s) are not approved.

However, before attempting to perform spins several items should be carefully considered to assure a safe flight. No spins should be attempted without first having received dual instruction both in spin entries and spin recoveries from a qualified instructor who is familiar with the spin characteristics of the Cessna 172N.

The cabin should be clean and all loose equipment (including the microphone and rear seat belts) should be stowed or secured. For a solo flight in which spins will be conducted, the copilot's seat belt and shoulder harness should also be secured. The seat belts and shoulder harnesses should be adjusted to provide proper restraint during all anticipated flight conditions. However, care should be taken to ensure that the pilot can easily reach the flight controls and produce maximum control travels.

It is recommended that, where feasible, entries be accomplished at high enough altitude that recoveries are completed 4000 feet or more above ground level. At least 1000 feet of altitude loss should be allowed for a 1-turn spin and recovery, while a 6-turn spin and recovery may require somewhat more than twice that amount. For example, the recommended entry altitude for a 6-turn spin would be 6000 feet above ground level. In any case, entries should be planned so that recoveries are completed well above the minimum 1500 feet above ground level required by FAR 91.71. Another reason for using high altitudes for practicing spins is that a greater field of view is provided which will assist in maintaining pilot orientation.

The normal entry is made from a power-off stall. As the stall is approached, the elevator control should be smoothly pulled to the full aft position. Just prior to reaching the stall "break", rudder control in the desired direction of the spin rotation should be applied so that full rudder deflection is reached almost simultaneously with reaching full aft elevator. A slightly greater rate of deceleration than for normal stall entries, application of ailerons in the direction of the desired spin, and the use of power at the entry will assure more consistent and positive entries to the spin. As the airplane begins to spin, reduce the power to idle and return the ailerons to neutral. Both elevator and rudder controls should be held full with the spin until the spin recovery is initiated. An inadvertent relaxation of either of these controls could result in the development of a nose-down spiral.

For the purpose of training in spins and spin recoveries, a 1 or 2 turn spin is adequate and should be used. Up to 2 turns, the spin will progress to a fairly rapid rate of rotation and a steep attitude. Application of recovery controls will produce prompt recoveries (within 1/4 turn). During ex-

tended spins of two to three turns or more, the spin will tend to change into a spiral, particularly to the right. This will be accompanied by an increase in airspeed and gravity loads on the airplane. If this occurs, recovery should be accomplished quickly by leveling the wings and recovering from the resulting dive.

Regardless of how many turns the spin is held or how it is entered, the following recovery technique should be used:

1. VERIFY THAT THROTTLE IS IN IDLE POSITION ANDAILERONS ARE NEUTRAL.
2. APPLY AND **HOLD** FULL RUDDER OPPOSITE TO THE DIRECTION OF ROTATION.
3. JUST **AFTER** THE RUDDER REACHES THE STOP, MOVE THE CONTROL WHEEL **BRISKLY** FORWARD FAR ENOUGH TO BREAK THE STALL.
4. **HOLD** THESE CONTROL INPUTS UNTIL ROTATION STOPS.
5. AS ROTATION STOPS, NEUTRALIZE RUDDER, AND MAKE A SMOOTH RECOVERY FROM THE RESULTING DIVE.

NOTE

If disorientation precludes a visual determination of the direction of rotation, the symbolic airplane in the turn coordinator may be referred to for this information.

Variations in basic airplane rigging or in weight and balance due to installed equipment or right seat occupancy can cause differences in behavior, particularly in extended spins. These differences are normal and will result in variations in the spin characteristics and in the spiraling tendencies for spins of more than 2 turns. However, the recovery technique should always be used and will result in the most expeditious recovery from any spin.

Intentional spins with flaps extended are prohibited, since the high speeds which may occur during recovery are potentially damaging to the flap/wing structure.

LANDING

NORMAL LANDING

Normal landing approaches can be made with power-on or power-off with any flap setting desired. Surface winds and air turbulence are usually the primary factors in determining the most comfortable approach speeds.

Steep slips should be avoided with flap settings greater than 20° due to a slight tendency for the elevator to oscillate under certain combinations of airspeed, sideslip angle, and center of gravity loadings.

NOTE

Carburetor heat should be applied prior to any significant reduction or closing of the throttle.

Actual touchdown should be made with power-off and on the main wheels first to reduce the landing speed and subsequent need for braking the landing roll. The nose wheel is lowered to the runway gently after the speed has diminished to avoid unnecessary nose gear loads. This procedure is especially important in rough or soft field landings.

SHORT FIELD LANDING

For a short field landing in smooth air conditions, make an approach at the minimum recommended airspeed with full flaps using enough power to control the glide path. (Slightly higher approach speeds should be used under turbulent air conditions.) After all approach obstacles are cleared, progressively reduce power and maintain the approach speed by lowering the nose of the airplane. Touchdown should be made with power off and on the main wheels first. Immediately after touchdown, lower the nose wheel and apply heavy braking as required. For maximum brake effectiveness, retract the flaps, hold the control wheel full back, and apply maximum brake pressure without sliding the tires.

CROSSWIND LANDING

When landing in a strong crosswind, use the minimum flap setting required for the field length. If flap settings greater than 20° are used in sideslips with full rudder deflection, some elevator oscillation may be felt at normal approach speeds. However, this does not affect control of the airplane. Although the crab or combination method of drift correction may be used, the wing-low method gives the best control. After touchdown, hold a straight course with the steerable nose wheel and occasional braking if necessary.

The maximum allowable crosswind velocity is dependent upon pilot capability as well as aircraft limitations. With average pilot technique, direct crosswinds of 15 knots can be handled with safety.

BALKED LANDING

In a bailed landing (go-around) climb, reduce the flap setting to 20° immediately after full power is applied. If obstacles must be cleared during

the go-around climb, reduce the wing flap setting to 10° and maintain a safe airspeed until the obstacles are cleared. Above 3000 feet, lean the mixture to obtain maximum RPM. After clearing any obstacles, the flaps may be retracted as the airplane accelerates to the normal flaps-up climb speed.

COLD WEATHER OPERATION

STARTING

Prior to starting on cold mornings, it is advisable to pull the propeller through several times by hand to "break loose" or "limber" the oil, thus conserving battery energy.

NOTE

When pulling the propeller through by hand, treat it as if the ignition switch is turned on. A loose or broken ground wire on either magneto could cause the engine to fire.

When air temperatures are below 20°F (-6°C), the use of an external preheater and an external power source are recommended whenever possible to obtain positive starting and to reduce wear and abuse to the engine and electrical system. Pre-heat will thaw the oil trapped in the oil cooler, which probably will be congealed prior to starting in extremely cold temperatures. When using an external power source, the position of the master switch is important. Refer to Section 9, Supplements, for Ground Service Plug Receptacle operating details.

Cold weather starting procedures are as follows:

With Preheat:

1. With ignition switch OFF and throttle closed, prime the engine four to eight strokes as the propeller is being turned over by hand.

NOTE

Use heavy strokes of primer for best atomization of fuel. After priming, push primer all the way in and turn to locked position to avoid possibility of engine drawing fuel through the primer.

2. Propeller Area -- CLEAR.
3. Avionics Power Switch -- OFF.
4. Master Switch -- ON.

5. Mixture -- FULL RICH.
6. Throttle -- OPEN 1/8 INCH.
7. Ignition Switch -- START.
8. Release ignition switch to BOTH when engine starts.
9. Oil Pressure -- CHECK.

Without Preheat:

1. Prime the engine six to ten strokes while the propeller is being turned by hand with the throttle closed. Leave the primer charged and ready for a stroke.
2. Propeller Area -- CLEAR.
3. Avionics Power Switch -- OFF.
4. Master Switch -- ON.
5. Mixture -- FULL RICH.
6. Ignition Switch -- START.
7. Pump throttle rapidly to full open twice. Return to 1/8 inch open position.
8. Release ignition switch to BOTH when engine starts.
9. Continue to prime engine until it is running smoothly, or alternately, pump throttle rapidly over first 1/4 of total travel.
10. Oil Pressure -- CHECK.
11. Pull carburetor heat knob full on after engine has started. Leave on until engine is running smoothly.
12. Primer -- LOCK.

NOTE

If the engine does not start during the first few attempts, or if engine firing diminishes in strength, it is probable that the spark plugs have been frosted over. Preheat must be used before another start is attempted.

CAUTION

Pumping the throttle may cause raw fuel to accumulate in the intake air duct, creating a fire hazard in the event of a backfire. If this occurs, maintain a cranking action to suck flames into the engine. An outside attendant with a fire extinguisher is advised for cold starts without preheat.

During cold weather operations no indication will be apparent on the oil temperature gage prior to takeoff if outside air temperatures are very cold. After a suitable warm-up period (2 to 5 minutes at 1000 RPM), accelerate the engine several times to higher engine RPM. If the engine accelerates smoothly and the oil pressure remains normal and steady, the airplane is ready for takeoff.

FLIGHT OPERATIONS

Takeoff is made normally with carburetor heat off. Avoid excessive leaning in cruise.

Carburetor heat may be used to overcome any occasional engine roughness due to ice.

When operating in temperatures below -18°C , avoid using partial carburetor heat. Partial heat may increase the carburetor air temperature to the 0° to 21°C range, where icing is critical under certain atmospheric conditions.

HOT WEATHER OPERATION

Refer to the general warm temperature starting information under Starting Engine in this section. Avoid prolonged engine operation on the ground.

NOISE ABATEMENT

Increased emphasis on improving the quality of our environment requires renewed effort on the part of all pilots to minimize the effect of airplane noise on the public.

We, as pilots, can demonstrate our concern for environmental improvement, by application of the following suggested procedures, and thereby tend to build public support for aviation:

1. Pilots operating aircraft under VFR over outdoor assemblies of persons, recreational and park areas, and other noise-sensitive areas should make every effort to fly not less than 2000 feet above the surface, weather permitting, even though flight at a lower level may be consistent with the provisions of government regulations.
2. During departure from or approach to an airport, climb after takeoff and descent for landing should be made so as to avoid prolonged flight at low altitude near noise-sensitive areas.

NOTE

The above recommended procedures do not apply where they would conflict with Air Traffic Control clearances or instructions, or where, in the pilot's judgment, an altitude

of less than 2000 feet is necessary for him to adequately exercise his duty to see and avoid other aircraft.

The certificated noise level for the Model 172N at 2300 pounds maximum weight is 73.8 dB(A). No determination has been made by the Federal Aviation Administration that the noise levels of this airplane are or should be acceptable or unacceptable for operation at, into, or out of, any airport.

SECTION 5 PERFORMANCE

TABLE OF CONTENTS

	Page
Introduction	5-3
Use of Performance Charts	5-3
Sample Problem	5-3
Takeoff	5-4
Cruise	5-5
Fuel Required	5-5
Landing	5-6
Demonstrated Operating Temperature	5-7
Figure 5-1, Airspeed Calibration - Normal Static Source	5-8
Airspeed Calibration - Alternate Static Source	5-9
Figure 5-2, Temperature Conversion Chart	5-10
Figure 5-3, Stall Speeds	5-11
Figure 5-4, Takeoff Distance - 2300 Lbs	5-12
Takeoff Distance - 2100 Lbs and 1900 Lbs	5-13
Figure 5-5, Maximum Rate Of Climb	5-14
Figure 5-6, Time, Fuel, And Distance To Climb	5-15
Figure 5-7, Cruise Performance	5-16
Figure 5-8, Range Profile - 40 Gallons Fuel	5-17
Range Profile - 50 Gallons Fuel	5-18
Figure 5-9, Endurance Profile - 40 Gallons Fuel	5-19
Endurance Profile - 50 Gallons Fuel	5-20
Figure 5-10, Landing Distance	5-21

SECTION 1 EFFECT OF RAIN

TABLE OF CONTENTS

Introduction	1
Objectives	2
Background	3
Methodology	4
Results	5
Discussion	6
Conclusion	7
References	8
Appendix A	9
Appendix B	10
Appendix C	11
Appendix D	12
Appendix E	13
Appendix F	14
Appendix G	15
Appendix H	16
Appendix I	17
Appendix J	18
Appendix K	19
Appendix L	20
Appendix M	21
Appendix N	22
Appendix O	23
Appendix P	24
Appendix Q	25
Appendix R	26
Appendix S	27
Appendix T	28
Appendix U	29
Appendix V	30
Appendix W	31
Appendix X	32
Appendix Y	33
Appendix Z	34

INTRODUCTION

Performance data charts on the following pages are presented so that you may know what to expect from the airplane under various conditions, and also, to facilitate the planning of flights in detail and with reasonable accuracy. The data in the charts has been computed from actual flight tests with the airplane and engine in good condition and using average piloting techniques.

It should be noted that the performance information presented in the range and endurance profile charts allows for 45 minutes reserve fuel at the specified power setting. Fuel flow data for cruise is based on the recommended lean mixture setting. Some indeterminate variables such as mixture leaning technique, fuel metering characteristics, engine and propeller condition, and air turbulence may account for variations of 10% or more in range and endurance. Therefore, it is important to utilize all available information to estimate the fuel required for the particular flight.

USE OF PERFORMANCE CHARTS

Performance data is presented in tabular or graphical form to illustrate the effect of different variables. Sufficiently detailed information is provided in the tables so that conservative values can be selected and used to determine the particular performance figure with reasonable accuracy.

SAMPLE PROBLEM

The following sample flight problem utilizes information from the various charts to determine the predicted performance data for a typical flight. The following information is known:

AIRPLANE CONFIGURATION

Takeoff weight	2300 Pounds
Usable fuel	40 Gallons

TAKEOFF CONDITIONS

Field pressure altitude	1500 Feet
Temperature	28°C (16°C above standard)
Wind component along runway	12 Knot Headwind
Field length	3500 Feet

CRUISE CONDITIONS

Total distance	320 Nautical Miles
Pressure altitude	5500 Feet
Temperature	20°C (16°C above standard)
Expected wind enroute	10 Knot Headwind

LANDING CONDITIONS

Field pressure altitude	2000 Feet
Temperature	25°C
Field length	3000 Feet

TAKEOFF

The takeoff distance chart, figure 5-4, should be consulted, keeping in mind that the distances shown are based on the short field technique. Conservative distances can be established by reading the chart at the next higher value of weight, altitude and temperature. For example, in this particular sample problem, the takeoff distance information presented for a weight of 2300 pounds, pressure altitude of 2000 feet and a temperature of 30°C should be used and results in the following:

Ground roll	1045 Feet
Total distance to clear a 50-foot obstacle	1885 Feet

These distances are well within the available takeoff field length. However, a correction for the effect of wind may be made based on Note 3 of the takeoff chart. The correction for a 12 knot headwind is:

$$\frac{12 \text{ Knots}}{9 \text{ Knots}} \times 10\% = 13\% \text{ Decrease}$$

This results in the following distances, corrected for wind:

Ground roll, zero wind	1045
Decrease in ground roll (1045 feet × 13%)	<u>136</u>
Corrected ground roll	909 Feet

Total distance to clear a 50-foot obstacle, zero wind	1885
Decrease in total distance (1885 feet × 13%)	<u>245</u>
Corrected total distance to clear 50-foot obstacle	1640 Feet

CRUISE

The cruising altitude should be selected based on a consideration of trip length, winds aloft, and the airplane's performance. A typical cruising altitude and the expected wind enroute have been given for this sample problem. However, the power setting selection for cruise must be determined based on several considerations. These include the cruise performance characteristics presented in figure 5-7, the range profile chart presented in figure 5-8, and the endurance profile chart presented in figure 5-9.

The relationship between power and range is illustrated by the range profile chart. Considerable fuel savings and longer range result when lower power settings are used. For this sample problem, a cruise power of approximately 65% will be used.

The cruise performance chart, figure 5-7, is entered at 6000 feet altitude and 20°C above standard temperature. These values most nearly correspond to the planned altitude and expected temperature conditions. The engine speed chosen is 2500 RPM, which results in the following:

Power	64%
True airspeed	114 Knots
Cruise fuel flow	7.1 GPH

The power computer may be used to determine power and fuel consumption more accurately during the flight.

FUEL REQUIRED

The total fuel requirement for the flight may be estimated using the performance information in figures 5-6 and 5-7. For this sample problem, figure 5-6 shows that a climb from 2000 feet to 6000 feet requires 1.3 gallons of fuel. The corresponding distance during the climb is 9 nautical miles. These values are for a standard temperature and are sufficiently accurate for most flight planning purposes. However, a further correction for the effect of temperature may be made as noted on the climb chart. The approximate effect of a non-standard temperature is to increase the time, fuel, and distance by 10% for each 10°C above standard temperature, due to the lower rate of climb. In this case, assuming a temperature 16°C above standard, the correction would be:

$$\frac{16^{\circ}\text{C}}{10^{\circ}\text{C}} \times 10\% = 16\% \text{ Increase}$$

With this factor included, the fuel estimate would be calculated as follows:

Fuel to climb, standard temperature	1.3
Increase due to non-standard temperature (1.3 × 16%)	<u>0.2</u>
Corrected fuel to climb	1.5 Gallons

Using a similar procedure for the distance to climb results in 10 nautical miles.

The resultant cruise distance is:

Total distance	320
Climb distance	<u>-10</u>
Cruise distance	310 Nautical Miles

With an expected 10 knot headwind, the ground speed for cruise is predicted to be:

$$\begin{array}{r} 114 \\ -10 \\ \hline 104 \text{ Knots} \end{array}$$

Therefore, the time required for the cruise portion of the trip is:

$$\frac{310 \text{ Nautical Miles}}{104 \text{ Knots}} = 3.0 \text{ Hours}$$

The fuel required for cruise is:

$$3.0 \text{ hours} \times 7.1 \text{ gallons/hour} = 21.3 \text{ Gallons}$$

The total estimated fuel required is as follows:

Engine start, taxi, and takeoff	1.1
Climb	1.5
Cruise	<u>21.3</u>
Total fuel required	23.9 Gallons

Once the flight is underway, ground speed checks will provide a more accurate basis for estimating the time enroute and the corresponding fuel required to complete the trip with ample reserve.

LANDING

A procedure similar to takeoff should be used for estimating the landing distance at the destination airport. Figure 5-10 presents landing

distance information for the short field technique. The distances corresponding to 2000 feet and 30°C are as follows:

Ground roll	590 Feet
Total distance to clear a 50-foot obstacle	1370 Feet

A correction for the effect of wind may be made based on Note 2 of the landing chart using the same procedure as outlined for takeoff.

DEMONSTRATED OPERATING TEMPERATURE

Satisfactory engine cooling has been demonstrated for this airplane with an outside air temperature 23°C above standard. This is not to be considered as an operating limitation. Reference should be made to Section 2 for engine operating limitations.

AIRSPEED CALIBRATION

NORMAL STATIC SOURCE

CONDITION:

Power required for level flight or maximum rated RPM dive.

FLAPS UP														
KIAS	40	50	60	70	80	90	100	110	120	130	140	150	160	
KCAS	50	56	63	71	80	89	99	109	119	129	139	149	160	
FLAPS 10°														
KIAS	40	50	60	70	80	90	100	110	---	---	---	---	---	
KCAS	49	55	62	71	80	90	99	108	---	---	---	---	---	
FLAPS 40°														
KIAS	40	50	60	70	80	85	---	---	---	---	---	---	---	
KCAS	48	55	63	72	82	87	---	---	---	---	---	---	---	

Figure 5-1. Airspeed Calibration (Sheet 1 of 2)

AIRSPEED CALIBRATION ALTERNATE STATIC SOURCE

HEATER/VENTS AND WINDOWS CLOSED

FLAPS UP											
NORMAL KIAS	40	50	60	70	80	90	100	110	120	130	140
ALTERNATE KIAS	39	51	61	71	82	91	101	111	121	131	141
FLAPS 10°											
NORMAL KIAS	40	50	60	70	80	90	100	110	---	---	---
ALTERNATE KIAS	40	51	61	71	81	90	99	108	---	---	---
FLAPS 40°											
NORMAL KIAS	40	50	60	70	80	85	---	---	---	---	---
ALTERNATE KIAS	38	50	60	70	79	83	---	---	---	---	---

HEATER/VENTS OPEN AND WINDOWS CLOSED

FLAPS UP											
NORMAL KIAS	40	50	60	70	80	90	100	110	120	130	140
ALTERNATE KIAS	36	48	59	70	80	89	99	108	118	128	139
FLAPS 10°											
NORMAL KIAS	40	50	60	70	80	90	100	110	---	---	---
ALTERNATE KIAS	38	49	59	69	79	88	97	106	---	---	---
FLAPS 40°											
NORMAL KIAS	40	50	60	70	80	85	---	---	---	---	---
ALTERNATE KIAS	34	47	57	67	77	81	---	---	---	---	---

WINDOWS OPEN

FLAPS UP											
NORMAL KIAS	40	50	60	70	80	90	100	110	120	130	140
ALTERNATE KIAS	26	43	57	70	82	93	103	113	123	133	143
FLAPS 10°											
NORMAL KIAS	40	50	60	70	80	90	100	110	---	---	---
ALTERNATE KIAS	25	43	57	69	80	91	101	111	---	---	---
FLAPS 40°											
NORMAL KIAS	40	50	60	70	80	85	---	---	---	---	---
ALTERNATE KIAS	25	41	54	67	78	84	---	---	---	---	---

Figure 5-1. Airspeed Calibration (Sheet 2 of 2)

TEMPERATURE CONVERSION CHART

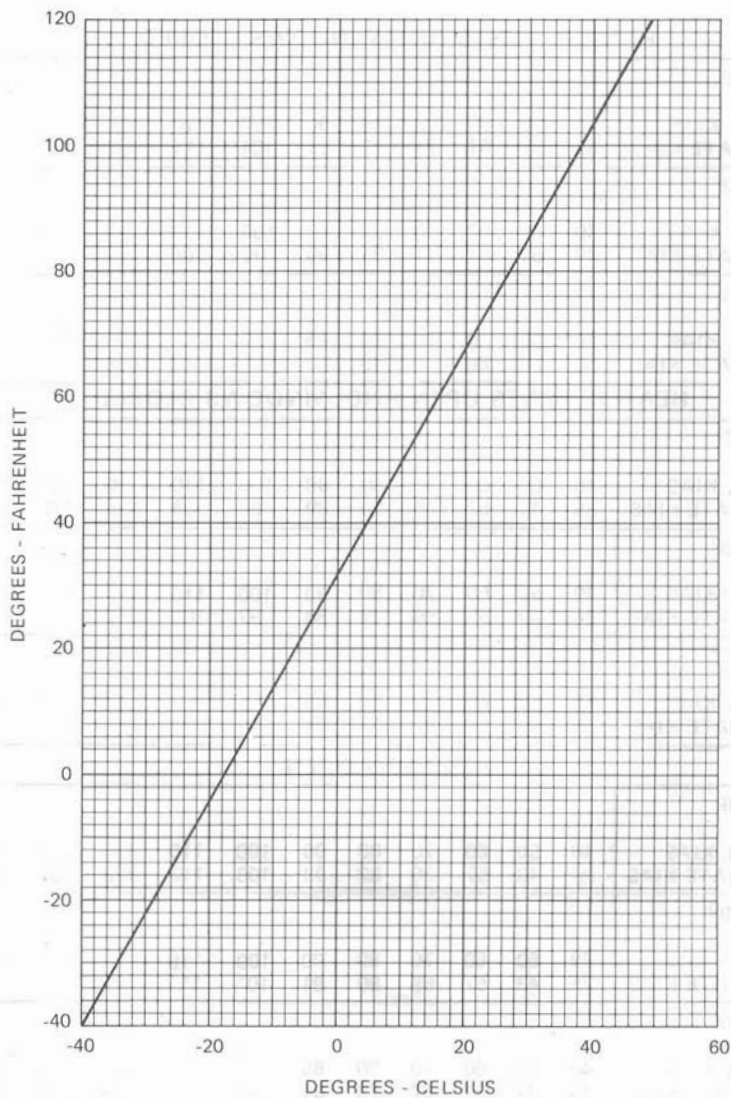

Figure 5-2. Temperature Conversion Chart

STALL SPEEDS

CONDITIONS:

Power Off

NOTES:

1. Maximum altitude loss during a stall recovery may be as much as 180 feet.
2. KIAS values are approximate.

MOST REARWARD CENTER OF GRAVITY

WEIGHT LBS	FLAP DEFLECTION	ANGLE OF BANK							
		0°		30°		45°		60°	
		KIAS	KCAS	KIAS	KCAS	KIAS	KCAS	KIAS	KCAS
2300	UP	39	50	42	54	47	59	56	71
	10°	38	47	40	51	45	56	54	66
	40°	31	44	33	47	37	52	45	62

MOST FORWARD CENTER OF GRAVITY

WEIGHT LBS	FLAP DEFLECTION	ANGLE OF BANK							
		0°		30°		45°		60°	
		KIAS	KCAS	KIAS	KCAS	KIAS	KCAS	KIAS	KCAS
2300	UP	44	53	47	57	52	63	62	75
	10°	44	51	47	55	52	61	62	72
	40°	33	47	35	51	39	56	47	66

Figure 5-3. Stall Speeds

TAKEOFF DISTANCE

MAXIMUM WEIGHT 2300 LBS

SHORT FIELD

CONDITIONS:

Flaps 10°
Full Throttle Prior to Brake Release
Paved, Level, Dry Runway
Zero Wind

NOTES:

- Short field technique as specified in Section 4.
- Prior to takeoff from fields above 3000 feet elevation, the mixture should be leaned to give maximum RPM in a full throttle, static runup.
- Decrease distances 10% for each 9 knots headwind. For operation with tailwinds up to 10 knots, increase distances by 10% for each 2 knots.
- For operation on a dry, grass runway, increase distances by 15% of the "ground roll" figure.

WEIGHT LBS	TAKEOFF SPEED KIAS		PRESS ALT FT	0°C			10°C			20°C			30°C			40°C			
	LIFT OFF	AT 50 FT		GRND ROLL	TO CLEAR 50 FT OBS	TOTAL ROLL	GRND ROLL	TO CLEAR 50 FT OBS	TOTAL ROLL	GRND ROLL	TO CLEAR 50 FT OBS	TOTAL ROLL	GRND ROLL	TO CLEAR 50 FT OBS	TOTAL ROLL	GRND ROLL	TO CLEAR 50 FT OBS	TOTAL ROLL	
2300	48	53	S.L.	695	1250	745	1340	805	1440	865	1545	925	1655	925	1545	925	1655	925	1655
			1000	760	1370	820	1475	880	1585	950	1705	1020	1830	1020	1705	1020	1830	1020	1830
			2000	835	1510	900	1625	970	1750	1045	1885	1120	2030	1120	1885	1120	2030	1120	2030
			3000	920	1670	990	1800	1070	1940	1150	2095	1235	2260	1235	2095	1235	2260	1235	2260
			4000	1010	1850	1090	2000	1180	2165	1270	2340	1365	2535	1365	2340	1365	2535	1365	2535
			5000	1115	2060	1205	2235	1300	2425	1405	2635	1510	2860	1510	2635	1510	2860	1510	2860
			6000	1235	2310	1335	2515	1440	2740	1555	2985	1675	3265	1675	2985	1675	3265	1675	3265
			7000	1370	2610	1480	2850	1600	3125	1730	3430	1865	3775	1865	3430	1865	3775	1865	3775
		8000	1520	2975	1645	3270	1780	3610	1925	4000	2080	4465	2080	4000	2080	4465	2080	4465	

Figure 5-4. Takeoff Distance (Sheet 1 of 2)

TAKEOFF DISTANCE

2100 LBS AND 1900 LBS

SHORT FIELD

REFER TO SHEET 1 FOR APPROPRIATE CONDITIONS AND NOTES.

WEIGHT LBS	TAKEOFF SPEED KIAS		PRESS ALT FT	0°C		10°C		20°C		30°C		40°C	
	LIFT OFF	AT 50 FT		GRND ROLL	TOTAL TO CLEAR 50 FT OBS	GRND ROLL	TOTAL TO CLEAR 50 FT OBS	GRND ROLL	TOTAL TO CLEAR 50 FT OBS	GRND ROLL	TOTAL TO CLEAR 50 FT OBS	GRND ROLL	TOTAL TO CLEAR 50 FT OBS
2100	46	51	S.L.	560	1020	605	1095	650	1170	700	1250	750	1340
			1000	615	1115	665	1195	715	1285	765	1375	820	1470
			2000	675	1225	725	1315	785	1410	840	1515	905	1625
			3000	740	1345	800	1445	860	1555	925	1670	995	1795
			4000	815	1485	880	1600	950	1720	1020	1855	1095	1995
			5000	900	1645	970	1775	1045	1915	1125	2065	1210	2225
			6000	990	1825	1070	1975	1155	2135	1245	2310	1340	2505
			7000	1095	2040	1185	2210	1280	2400	1380	2605	1485	2835
			8000	1215	2295	1315	2495	1420	2720	1530	2965	1650	3245
1900	43	48	S.L.	450	820	480	880	520	940	555	1000	595	1070
			1000	490	895	525	960	565	1025	610	1095	655	1170
			2000	535	980	580	1050	620	1120	665	1200	715	1280
			3000	590	1070	635	1150	680	1230	735	1315	785	1410
			4000	645	1175	695	1260	750	1355	805	1450	865	1555
			5000	710	1295	765	1390	825	1495	890	1605	955	1725
			6000	785	1430	845	1540	910	1655	980	1785	1055	1920
			7000	865	1585	935	1710	1005	1845	1085	1990	1165	2145
			8000	955	1765	1030	1905	1115	2060	1200	2230	1290	2410

Figure 5-4. Takeoff Distance (Sheet 2 of 2)

MAXIMUM RATE OF CLIMB

CONDITIONS:
Flaps Up
Full Throttle

NOTE:
Mixture leaned above 3000 feet for maximum RPM.

WEIGHT LBS	PRESS ALT FT	CLIMB SPEED KIAS	RATE OF CLIMB - FPM			
			-20°C	0°C	20°C	40°C
2300	S.L.	73	875	815	755	695
	2000	72	765	705	650	590
	4000	71	655	600	545	485
	6000	70	545	495	440	385
	8000	69	440	390	335	280
	10,000	68	335	285	230	---
	12,000	67	230	180	---	---

Figure 5-5. Maximum Rate of Climb

TIME, FUEL, AND DISTANCE TO CLIMB

MAXIMUM RATE OF CLIMB

CONDITIONS:

Flaps Up
Full Throttle
Standard Temperature

NOTES:

1. Add 1.1 gallons of fuel for engine start, taxi and takeoff allowance. ✓
2. Mixture leaned above 3000 feet for maximum RPM.
3. Increase time, fuel and distance by 10% for each 10°C above standard temperature.
4. Distances shown are based on zero wind.

WEIGHT LBS	PRESSURE ALTITUDE FT	TEMP °C	CLIMB SPEED KIAS	RATE OF CLIMB FPM	FROM SEA LEVEL		
					TIME MIN	FUEL USED GALLONS	DISTANCE NM
2300	S.L.	15	73	770	0	0.0	0
	1000	13	73	725	1	0.3	2
	2000	11	72	675	3	0.6	3
	3000	9	72	630	4	0.9	5
	4000	7	71	580	6	1.2	8
	5000	5	71	535	8	1.6	10
	6000	3	70	485	10	1.9	12
	7000	1	69	440	12	2.3	15
	8000	-1	69	390	15	2.7	19
	9000	-3	68	345	17	3.2	22
	10,000	-5	68	295	21	3.7	27
	11,000	-7	67	250	24	4.2	32
12,000	-9	67	200	29	4.9	38	

Figure 5-6. Time, Fuel, and Distance to Climb

CRUISE PERFORMANCE

CONDITIONS:

2300 Pounds

Recommended Lean Mixture

PRESSURE ALTITUDE FT	RPM	20°C BELOW STANDARD TEMP			STANDARD TEMPERATURE			20°C ABOVE STANDARD TEMP		
		% BHP	KTAS	GPH	% BHP	KTAS	GPH	% BHP	KTAS	GPH
2000	2500	---	---	---	75	116	8.4	71	115	7.9
	2400	72	111	8.0	67	111	7.5	63	110	7.1
	2300	64	106	7.1	60	105	6.7	56	105	6.3
	2200	56	101	6.3	53	100	6.1	50	99	5.8
	2100	50	95	5.8	47	94	5.6	45	93	5.4
4000	2550	---	---	---	75	118	8.4	71	118	7.9
	2500	76	116	8.5	71	115	8.0	67	115	7.5
	2400	68	111	7.6	64	110	7.1	60	109	6.7
	2300	60	105	6.8	57	105	6.4	54	104	6.1
	2200	54	100	6.1	51	99	5.9	48	98	5.7
2100	48	94	5.6	46	93	5.5	44	92	5.3	
6000	2600	---	---	---	75	120	8.4	71	120	7.9
	2500	72	116	8.1	67	115	7.6	64	114	7.1
	2400	64	110	7.2	60	109	6.8	57	109	6.4
	2300	57	105	6.5	54	104	6.2	52	103	5.9
	2200	51	99	5.9	49	98	5.7	47	97	5.5
2100	46	93	5.5	44	92	5.4	42	91	5.2	
8000	2650	---	---	---	75	122	8.4	71	122	7.9
	2600	76	120	8.6	71	120	8.0	67	119	7.5
	2500	68	115	7.7	64	114	7.2	60	113	6.8
	2400	61	110	6.9	58	109	6.5	55	108	6.2
	2300	55	104	6.2	52	103	6.0	50	102	5.8
2200	49	98	5.7	47	97	5.5	45	96	5.4	
10,000	2650	76	122	8.5	71	122	8.0	67	121	7.5
	2600	72	120	8.1	68	119	7.6	64	118	7.1
	2500	65	114	7.3	61	114	6.8	58	112	6.5
	2400	58	109	6.5	55	108	6.2	52	107	6.0
	2300	52	103	6.0	50	102	5.8	48	101	5.6
2200	47	97	5.6	45	96	5.4	44	95	5.3	
12,000	2600	68	119	7.7	64	118	7.2	61	117	6.8
	2500	62	114	6.9	58	113	6.5	55	111	6.2
	2400	56	108	6.3	53	107	6.0	51	106	5.8
	2300	50	102	5.8	48	101	5.6	46	100	5.5
	2200	46	96	5.5	44	95	5.4	43	94	5.3

Figure 5-7. Cruise Performance

RANGE PROFILE 45 MINUTES RESERVE 40 GALLONS USABLE FUEL

CONDITIONS:

2300 Pounds
Recommended Lean Mixture for Cruise
Standard Temperature
Zero Wind

NOTE:

This chart allows for the fuel used for engine start, taxi, takeoff and climb, and the distance during climb.

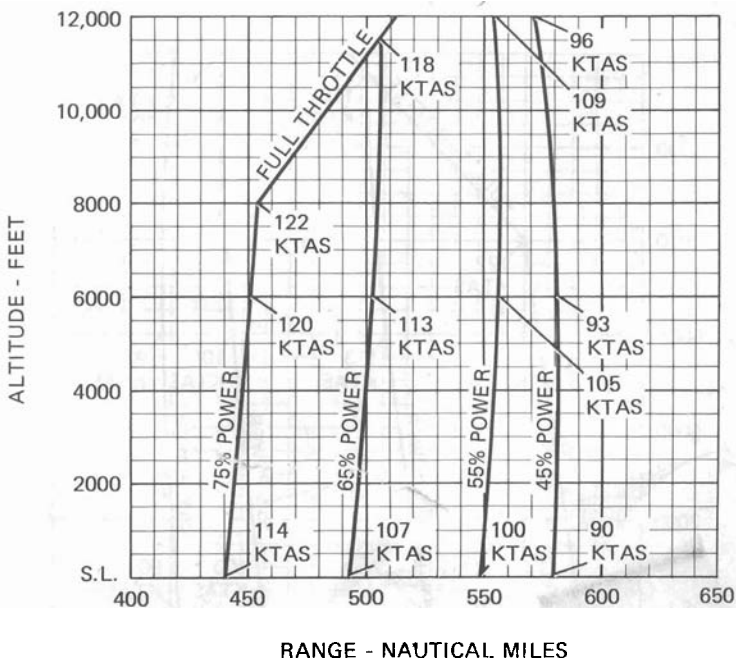

Figure 5-8. Range Profile (Sheet 1 of 2)

RANGE PROFILE 45 MINUTES RESERVE 50 GALLONS USABLE FUEL

CONDITIONS:

2300 Pounds
Recommended Lean Mixture for Cruise
Standard Temperature
Zero Wind

NOTE:

This chart allows for the fuel used for engine start, taxi, takeoff and climb, and the distance during climb.

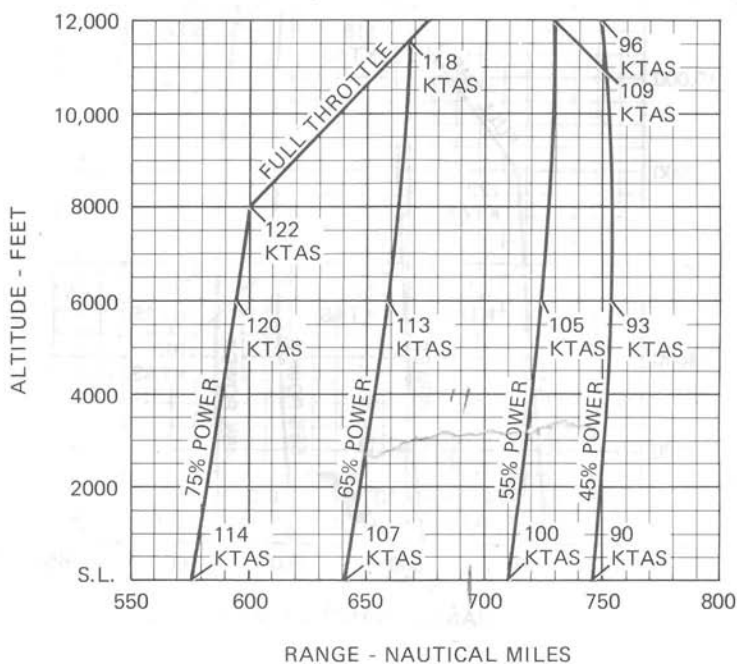

Figure 5-8. Range Profile (Sheet 2 of 2)

ENDURANCE PROFILE 45 MINUTES RESERVE 40 GALLONS USABLE FUEL

CONDITIONS:
2300 Pounds
Recommended Lean Mixture for Cruise
Standard Temperature

NOTE:
This chart allows for the fuel used for engine start, taxi, takeoff and climb, and the time during climb.

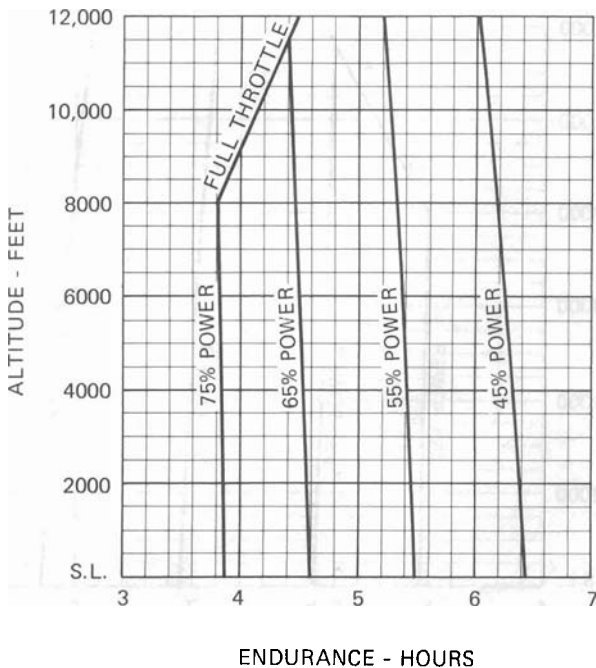

Figure 5-9. Endurance Profile (Sheet 1 of 2)

ENDURANCE PROFILE

45 MINUTES RESERVE
50 GALLONS USABLE FUEL

CONDITIONS:

2300 Pounds
Recommended Lean Mixture for Cruise
Standard Temperature

NOTE:

This chart allows for the fuel used for engine start, taxi, takeoff and climb, and the time during climb.

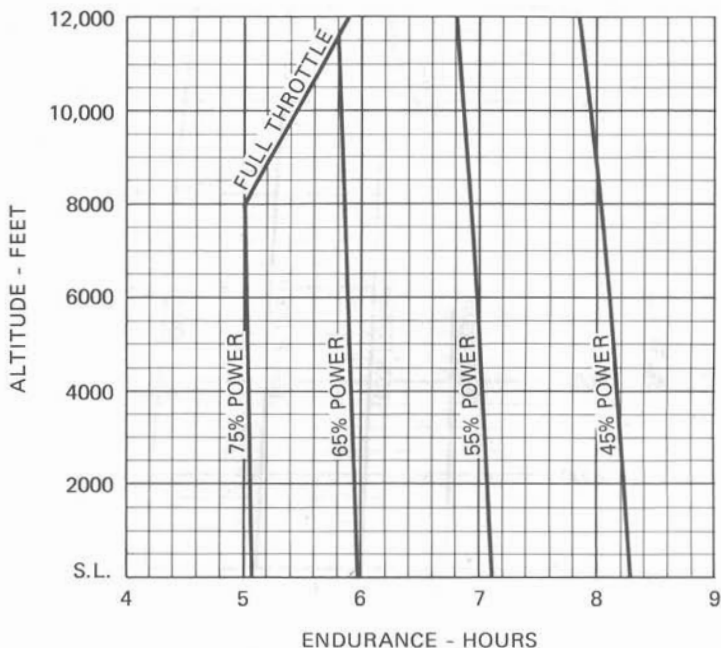

Figure 5-9. Endurance Profile (Sheet 2 of 2)

LANDING DISTANCE

SHORT FIELD

CONDITIONS:

Flaps 40°
Power Off
Maximum Braking
Paved, Level, Dry Runway
Zero Wind

NOTES:

1. Short field technique as specified in Section 4.
2. Decrease distances 10% for each 9 knots headwind. For operation with tailwinds up to 10 knots, increase distances by 10% for each 2 knots
3. For operation on a dry, grass runway, increase distances by 45% of the "ground roll" figure.

WEIGHT LBS	SPEED AT 50 FT KIAS	PRESS ALT FT	0°C		10°C		20°C		30°C		40°C	
			GRND ROLL	TOTAL TO CLEAR 50 FT OBS	GRND ROLL	TOTAL TO CLEAR 50 FT OBS	GRND ROLL	TOTAL TO CLEAR 50 FT OBS	GRND ROLL	TOTAL TO CLEAR 50 FT OBS	GRND ROLL	TOTAL TO CLEAR 50 FT OBS
2300	59	S.L.	495	1205	510	1235	530	1265	545	1295	565	1330
		1000	510	1235	530	1265	550	1300	565	1330	585	1365
		2000	530	1265	550	1300	570	1335	590	1370	610	1405
		3000	550	1300	570	1335	590	1370	610	1405	630	1440
		4000	570	1335	590	1370	615	1410	635	1445	655	1480
		5000	590	1370	615	1415	635	1450	655	1485	680	1525
		6000	615	1415	640	1455	660	1490	685	1535	705	1570
		7000	640	1455	660	1495	685	1535	710	1575	730	1615
		8000	665	1500	690	1540	710	1580	735	1620	760	1665

Figure 5-10. Landing Distance

ADMINISTRATIVE DIVISION

1 10 1964

PROPERTY		DEPT		USE		LOCATION	
NO.	DESCRIPTION	NO.	DESCRIPTION	NO.	DESCRIPTION	NO.	DESCRIPTION
1001	...	1001	...	1001	...	1001	...
1002	...	1002	...	1002	...	1002	...
1003	...	1003	...	1003	...	1003	...
1004	...	1004	...	1004	...	1004	...
1005	...	1005	...	1005	...	1005	...
1006	...	1006	...	1006	...	1006	...
1007	...	1007	...	1007	...	1007	...
1008	...	1008	...	1008	...	1008	...
1009	...	1009	...	1009	...	1009	...
1010	...	1010	...	1010	...	1010	...
1011	...	1011	...	1011	...	1011	...
1012	...	1012	...	1012	...	1012	...
1013	...	1013	...	1013	...	1013	...
1014	...	1014	...	1014	...	1014	...
1015	...	1015	...	1015	...	1015	...
1016	...	1016	...	1016	...	1016	...
1017	...	1017	...	1017	...	1017	...
1018	...	1018	...	1018	...	1018	...
1019	...	1019	...	1019	...	1019	...
1020	...	1020	...	1020	...	1020	...

1. All materials in ...
 2. ...
 3. ...
 4. ...
 5. ...

SECTION 6 WEIGHT & BALANCE/ EQUIPMENT LIST

TABLE OF CONTENTS

	Page
Introduction	6-3
Airplane Weighing Procedures	6-3
Weight And Balance	6-6
Equipment List	6-13

WERNER & CO. INC.
ELECTRICAL

LABORERS

1910

INTRODUCTION

This section describes the procedure for establishing the basic empty weight and moment of the airplane. Sample forms are provided for reference. Procedures for calculating the weight and moment for various operations are also provided. A comprehensive list of all Cessna equipment available for this airplane is included at the back of this section.

It should be noted that specific information regarding the weight, arm, moment and installed equipment list for this airplane can only be found in the appropriate weight and balance records carried in the airplane.

It is the responsibility of the pilot to ensure that the airplane is loaded properly.

AIRPLANE WEIGHING PROCEDURES

1. Preparation:
 - a. Inflate tires to recommended operating pressures.
 - b. Remove the fuel tank sump quick-drain fittings and fuel selector valve drain plug to drain all fuel.
 - c. Remove oil sump drain plug to drain all oil.
 - d. Move sliding seats to the most forward position.
 - e. Raise flaps to the fully retracted position.
 - f. Place all control surfaces in neutral position.
2. Leveling:
 - a. Place scales under each wheel (minimum scale capacity, 500 pounds nose, 1000 pounds each main).
 - b. Deflate the nose tire and/or lower or raise the nose strut to properly center the bubble in the level (see figure 6-1).
3. Weighing:
 - a. With the airplane level and brakes released, record the weight shown on each scale. Deduct the tare, if any, from each reading.
4. Measuring:
 - a. Obtain measurement A by measuring horizontally (along the airplane center line) from a line stretched between the main wheel centers to a plumb bob dropped from the firewall.
 - b. Obtain measurement B by measuring horizontally and parallel to the airplane center line, from center of nose wheel axle, left side, to a plumb bob dropped from the line between the main wheel centers. Repeat on right side and average the measurements.
5. Using weights from item 3 and measurements from item 4, the airplane weight and C.G. can be determined.
6. Basic Empty Weight may be determined by completing figure 6-1.

SECTION 6
WEIGHT & BALANCE/
EQUIPMENT LIST

CESSNA
MODEL 172N

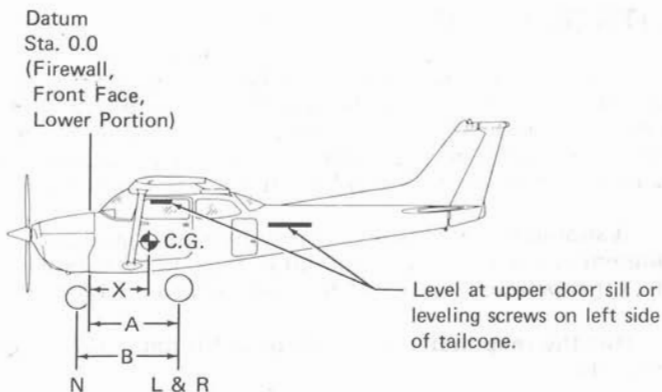

Scale Position	Scale Reading	Tare	Symbol	Net Weight
Left Wheel			L	
Right Wheel			R	
Nose Wheel			N	
Sum of Net Weights (As Weighed)			W	

$$X = \text{ARM} = \frac{(A) - (N) \times (B)}{W}; X = (\quad) - (\quad) \times (\quad) = (\quad) \text{ IN.}$$

Item	Weight (Lbs.)	X C.G. Arm (In.)	Moment/1000 (Lbs.-In.)
Airplane Weight (From Item 5, page 6-3)			
Add Oil:			
No Oil Filter (6 Qts at 7.5 Lbs/Gal)		-14.0	
With Oil Filter (7 Qts at 7.5 Lbs/Gal)		-14.0	
Add Unusable Fuel:			
Std. Tanks (3 Gal at 6 Lbs/Gal)		46.0	
L.R. Tanks (4 Gal at 6 Lbs/Gal)		46.0	
Equipment Changes			
Airplane Basic Empty Weight			

Figure 6-1. Sample Airplane Weighing

SAMPLE WEIGHT AND BALANCE RECORD

(Continuous History of Changes in Structure or Equipment Affecting Weight and Balance)

AIRPLANE MODEL			SERIAL NUMBER						PAGE NUMBER			
DATE	ITEM NO.		DESCRIPTION OF ARTICLE OR MODIFICATION	WEIGHT CHANGE						RUNNING BASIC EMPTY WEIGHT		
	In	Out		ADDED (+)			REMOVED (-)			Wt. (lb.)	Moment /1000	
				Wt. (lb.)	Arm (In.)	Moment /1000	Wt. (lb.)	Arm (In.)	Moment /1000			

Figure 6-2. Sample Weight and Balance Record

WEIGHT AND BALANCE

The following information will enable you to operate your Cessna within the prescribed weight and center of gravity limitations. To figure weight and balance, use the Sample Problem, Loading Graph, and Center of Gravity Moment Envelope as follows:

Take the basic empty weight and moment from appropriate weight and balance records carried in your airplane, and enter them in the column titled YOUR AIRPLANE on the Sample Loading Problem.

NOTE

In addition to the basic empty weight and moment noted on these records, the C.G. arm (fuselage station) is also shown, but need not be used on the Sample Loading Problem. The moment which is shown must be divided by 1000 and this value used as the moment/1000 on the loading problem.

Use the Loading Graph to determine the moment/1000 for each additional item to be carried; then list these on the loading problem.

NOTE

Loading Graph information for the pilot, passengers and baggage is based on seats positioned for average occupants and baggage loaded in the center of the baggage areas as shown on the Loading Arrangements diagram. For loadings which may differ from these, the Sample Loading Problem lists fuselage stations for these items to indicate their forward and aft C.G. range limitations (seat travel and baggage area limitation). Additional moment calculations, based on the actual weight and C.G. arm (fuselage station) of the item being loaded, must be made if the position of the load is different from that shown on the Loading Graph.

Total the weights and moments/1000 and plot these values on the Center of Gravity Moment Envelope to determine whether the point falls within the envelope, and if the loading is acceptable.

LOADING ARRANGEMENTS

*Pilot or passenger center of gravity on adjustable seats positioned for average occupant. Numbers in parentheses indicate forward and aft limits of occupant center of gravity range.

**Arm measured to the center of the areas shown.

- NOTES:
1. The usable fuel C.G. arm for standard and long range tanks is located at station 48:0.
 2. The rear cabin wall (approximate station 108) or aft baggage wall (approximate station 142) can be used as convenient interior reference points for determining the location of baggage area fuselage stations.

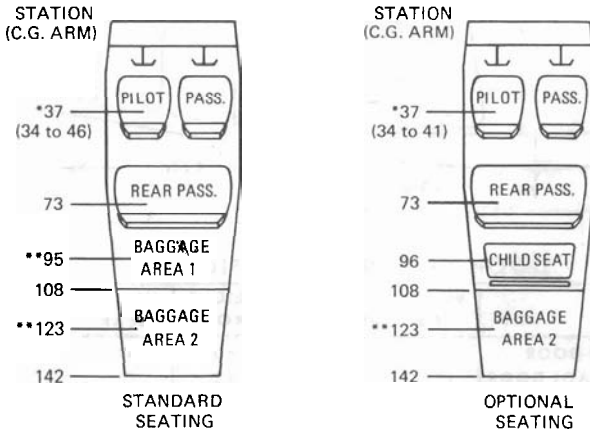
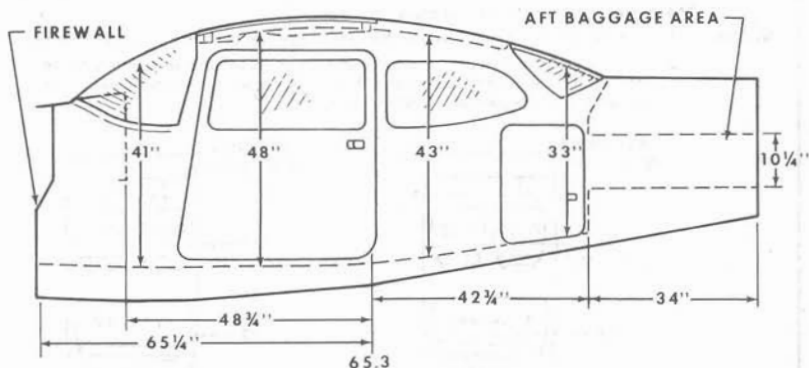

Figure 6-3. Loading Arrangements

CABIN HEIGHT MEASUREMENTS



DOOR OPENING DIMENSIONS

	WIDTH (TOP)	WIDTH (BOTTOM)	HEIGHT (FRONT)	HEIGHT (REAR)
CABIN DOOR	32"	37"	40"	41"
BAGGAGE DOOR	15 1/4"	15 1/4"	22"	21"

— WIDTH —
● LWR WINDOW LINE
* CABIN FLOOR

CABIN WIDTH MEASUREMENTS

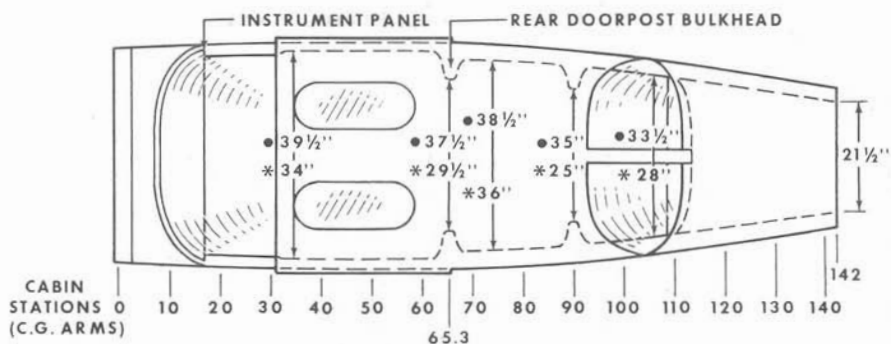

Figure 6-4. Internal Cabin Dimensions

SAMPLE LOADING PROBLEM	SAMPLE AIRPLANE		YOUR AIRPLANE	
	Weight (lbs.)	Moment (lb. - ins. /1000)	Weight (lbs.)	Moment (lb. - ins. /1000)
1. Basic Empty Weight (Use the data pertaining to your airplane as it is presently equipped. Includes unusable fuel and full oil)	1454	57.6		
2. Usable Fuel (At 6 Lbs./Gal.) Standard Tanks (40 Gal. Maximum)	240	11.5		
Long Range Tanks (50 Gal. Maximum)				
3. Pilot and Front Passenger (Station 34 to 46)	340	12.6		
4. Rear Passengers	170	12.4		
5. *Baggage Area 1 or Passenger on Child's Seat (Station 82 to 108, 120 Lbs. Max.)	103	9.8		
6. *Baggage Area 2 (Station 108 to 142, 50 Lbs. Max.)				
7. RAMP WEIGHT AND MOMENT	2307	103.9		
8. Fuel allowance for engine start, taxi, and runup	-7	-.3		
9. TAKEOFF WEIGHT AND MOMENT (Subtract Step 8 from Step 7)	2300	103.6		
10. Locate this point (2300 at 103.6) on the Center of Gravity Moment Envelope, and since this point falls within the envelope, the loading is acceptable. <p style="text-align: center;">* The maximum allowable combined weight capacity for baggage areas 1 and 2 is 120 lbs.</p>				

Figure 6-5. Sample Loading Problem

SECTION 6
WEIGHT & BALANCE/
EQUIPMENT LIST

CESSNA
MODEL 172N

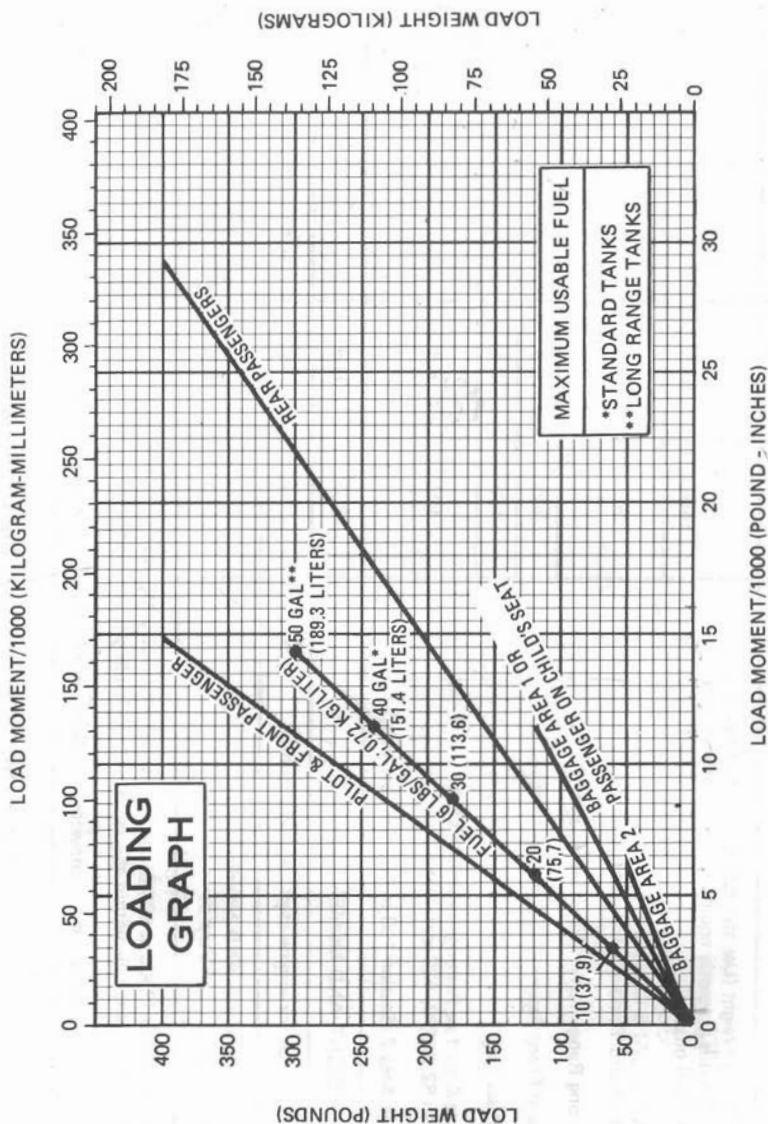

NOTE: Line representing adjustable seats shows the pilot or passenger center of gravity on adjustable seats positioned for an average occupant. Refer to the Loading Arrangements diagram for forward and aft limits of occupant C.G. range.

Figure 6-6. Loading Graph

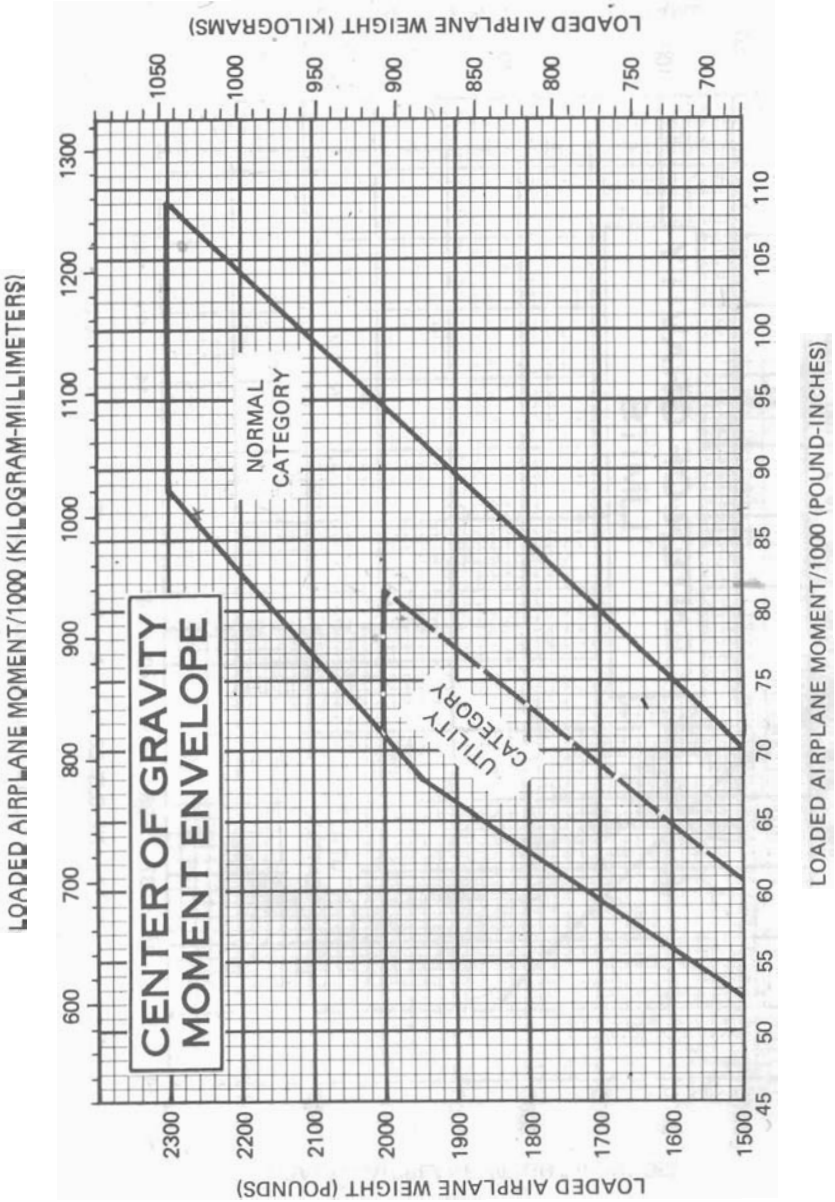

Figure 6-7. Center of Gravity Moment Envelope

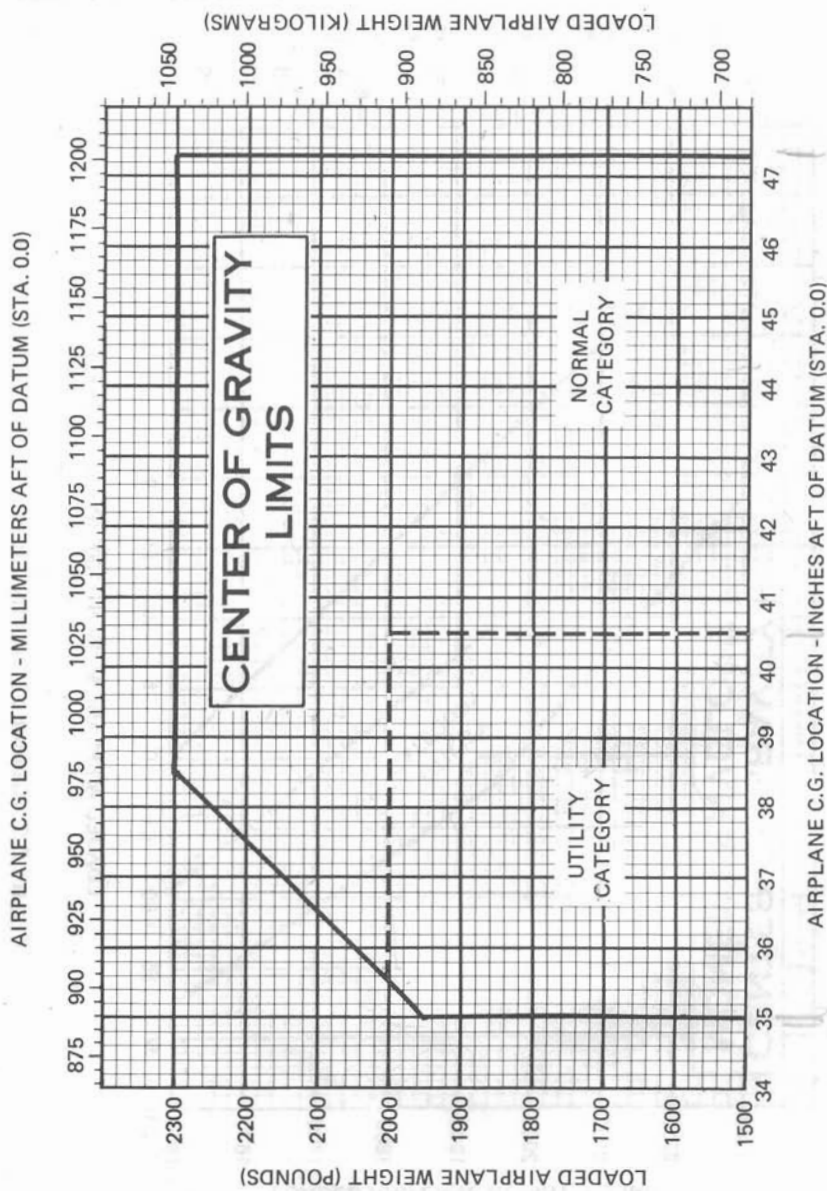

Figure 6-8. Center of Gravity Limits

SECTION 7 AIRPLANE & SYSTEMS DESCRIPTIONS

TABLE OF CONTENTS

	Page
Introduction	7-3
Airframe	7-3
Flight Controls	7-8
Trim System	7-8
Instrument Panel	7-8
Ground Control	7-9
Wing Flap System	7-10
Landing Gear System	7-10
Baggage Compartment	7-11
Seats	7-11
Seat Belts And Shoulder Harnesses	7-12
Seat Belts	7-12
Shoulder Harnesses	7-12
Integrated Seat Belt/Shoulder Harnesses With Inertia Reels	7-14
Entrance Doors And Cabin Windows	7-15
Control Locks	7-16
Engine	7-16
Engine Controls	7-16
Engine Instruments	7-17
New Engine Break-In And Operation	7-18
Engine Oil System	7-18
Ignition-Starter System	7-19
Air Induction System	7-19
Exhaust System	7-19
Carburetor And Priming System	7-19
Cooling System	7-20
Propeller	7-20
Fuel System	7-20
Brake System	7-23
Electrical System	7-23
Master Switch	7-25
Avionics Power Switch	7-25

TABLE OF CONTENTS (Continued)

	Page
Ammeter	7-26
Alternator Control Unit And Low-Voltage Warning Light	7-26
Circuit Breakers And Fuses	7-27
Ground Service Plug Receptacle	7-27
Lighting Systems	7-27
Exterior Lighting	7-27
Interior Lighting	7-28
Cabin Heating, Ventilating And Defrosting System	7-29
Pitot-Static System And Instruments	7-31
Airspeed Indicator	7-31
Vertical Speed Indicator	7-32
Altimeter	7-32
Vacuum System And Instruments	7-32
Attitude Indicator	7-32
Directional Indicator	7-34
Suction Gage	7-34
Stall Warning System	7-34
Avionics Support Equipment	7-34
Audio Control Panel	7-35
Transmitter Selector Switch	7-35
Audio Selector Switches	7-35
Com Auto Audio Selector Switch	7-37
Com Both Audio Selector Switch	7-37
Auto Audio Selector Switch	7-38
Annunciator Lights Brightness And Test Switch	7-38
Sidetone Operation	7-38
Microphone - Headset Installations	7-39
Static Dischargers	7-40

INTRODUCTION

This section provides description and operation of the airplane and its systems. Some equipment described herein is optional and may not be installed in the airplane. Refer to Section 9, Supplements, for details of other optional systems and equipment.

AIRFRAME

The airplane is an all-metal, four-place, high-wing, single-engine airplane equipped with tricycle landing gear and designed for general utility purposes.

The construction of the fuselage is a conventional formed sheet metal bulkhead, stringer, and skin design referred to as semimonocoque. Major items of structure are the front and rear carry-through spars to which the wings are attached, a bulkhead and forgings for main landing gear attachment at the base of the rear door posts, and a bulkhead with attach fittings at the base of the forward door posts for the lower attachment of the wing struts. Four engine mount stringers are also attached to the forward door posts and extend forward to the firewall.

The externally braced wings, containing the fuel tanks, are constructed of a front and rear spar with formed sheet metal ribs, doublers, and stringers. The entire structure is covered with aluminum skin. The front spars are equipped with wing-to-fuselage and wing-to-strut attach fittings. The aft spars are equipped with wing-to-fuselage attach fittings, and are partial-span spars. Conventional hinged ailerons and single-slot type flaps are attached to the trailing edge of the wings. The ailerons are constructed of a forward spar containing balance weights, formed sheet metal ribs and "V" type corrugated aluminum skin joined together at the trailing edge. The flaps are constructed basically the same as the ailerons, with the exception of the balance weights and the addition of a formed sheet metal leading edge section.

The empennage (tail assembly) consists of a conventional vertical stabilizer, rudder, horizontal stabilizer, and elevator. The vertical stabilizer consists of a spar, formed sheet metal ribs and reinforcements, a wrap-around skin panel, formed leading edge skin and a dorsal. The rudder is constructed of a formed leading edge skin containing hinge halves, a center wrap-around skin panel, ribs, an aft wrap-around skin panel which is joined at the trailing edge of the rudder by a filler strip, and a ground adjustable trim tab at the base of the trailing edge. The top of the rudder incorporates a leading edge extension which contains a balance weight.

AILERON CONTROL SYSTEM

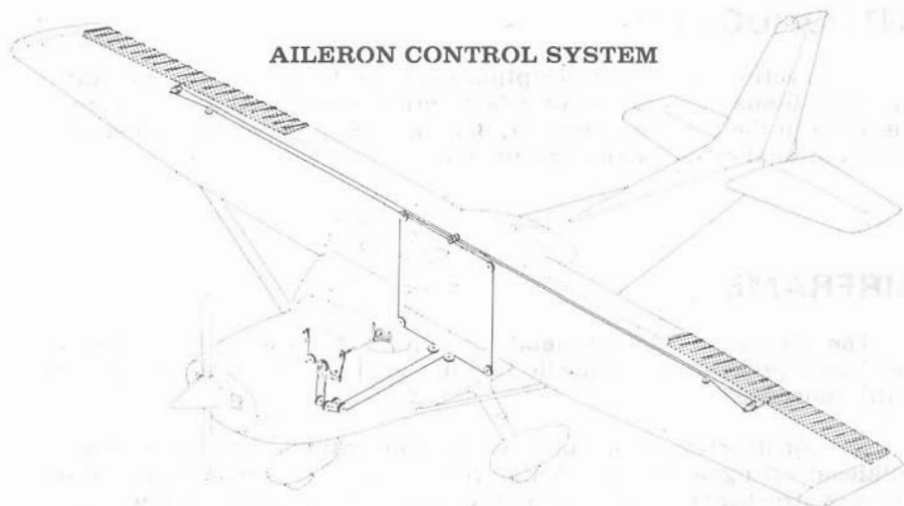

**RUDDER AND RUDDER TRIM
CONTROL SYSTEMS**

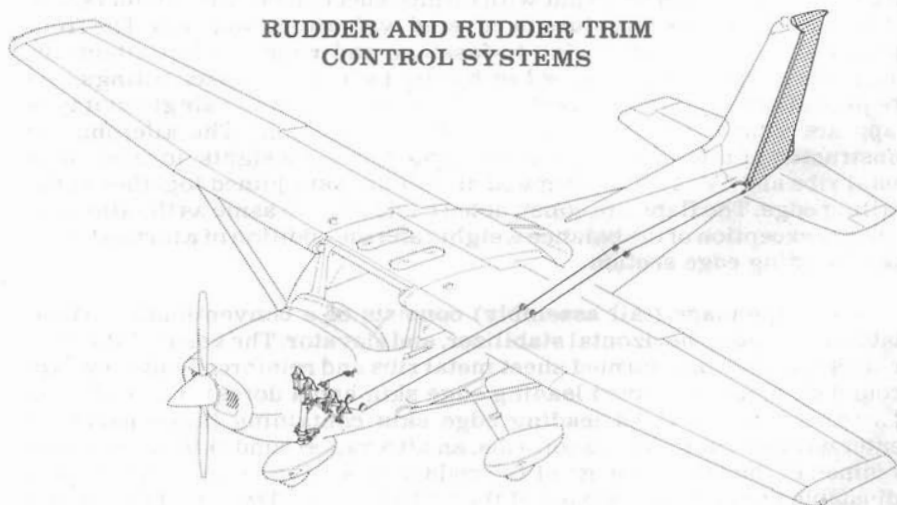

Figure 7-1. Flight Control and Trim Systems (Sheet 1 of 2)

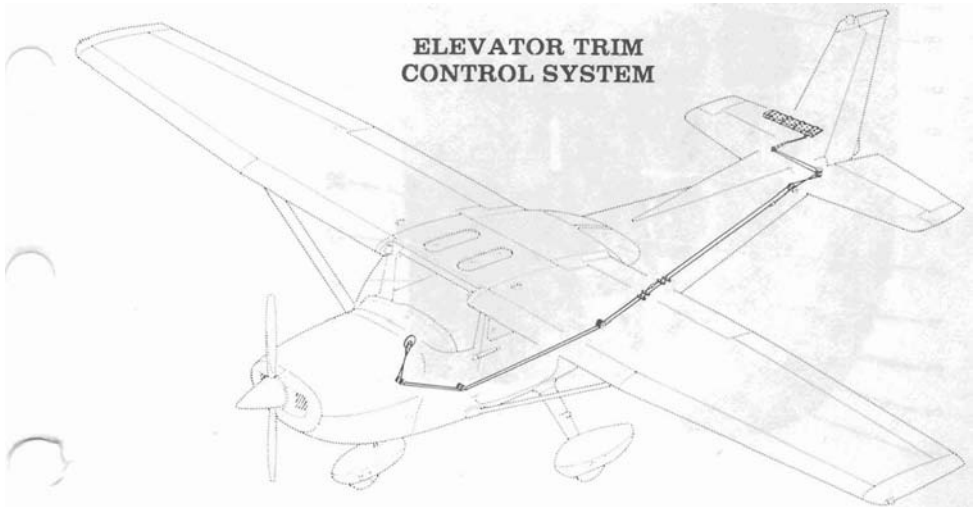
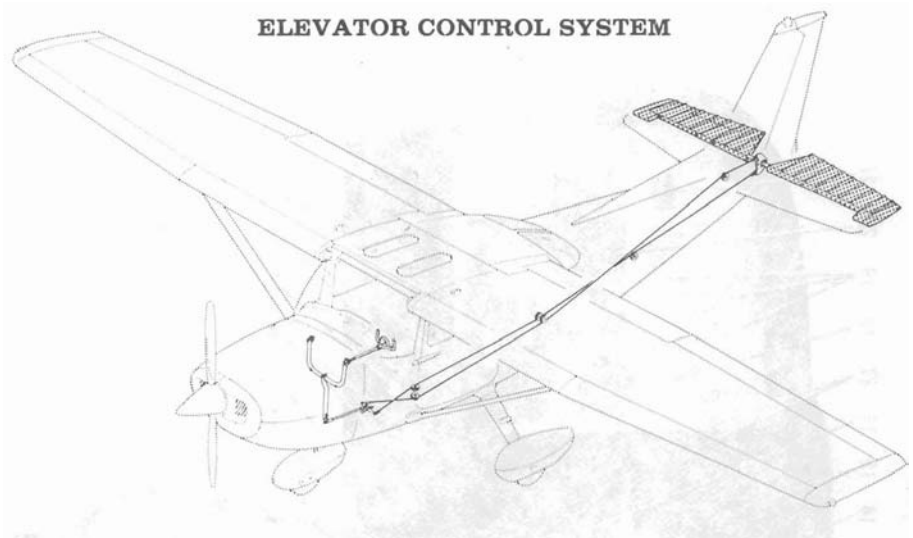

Figure 7-1. Flight Control and Trim Systems (Sheet 2 of 2)

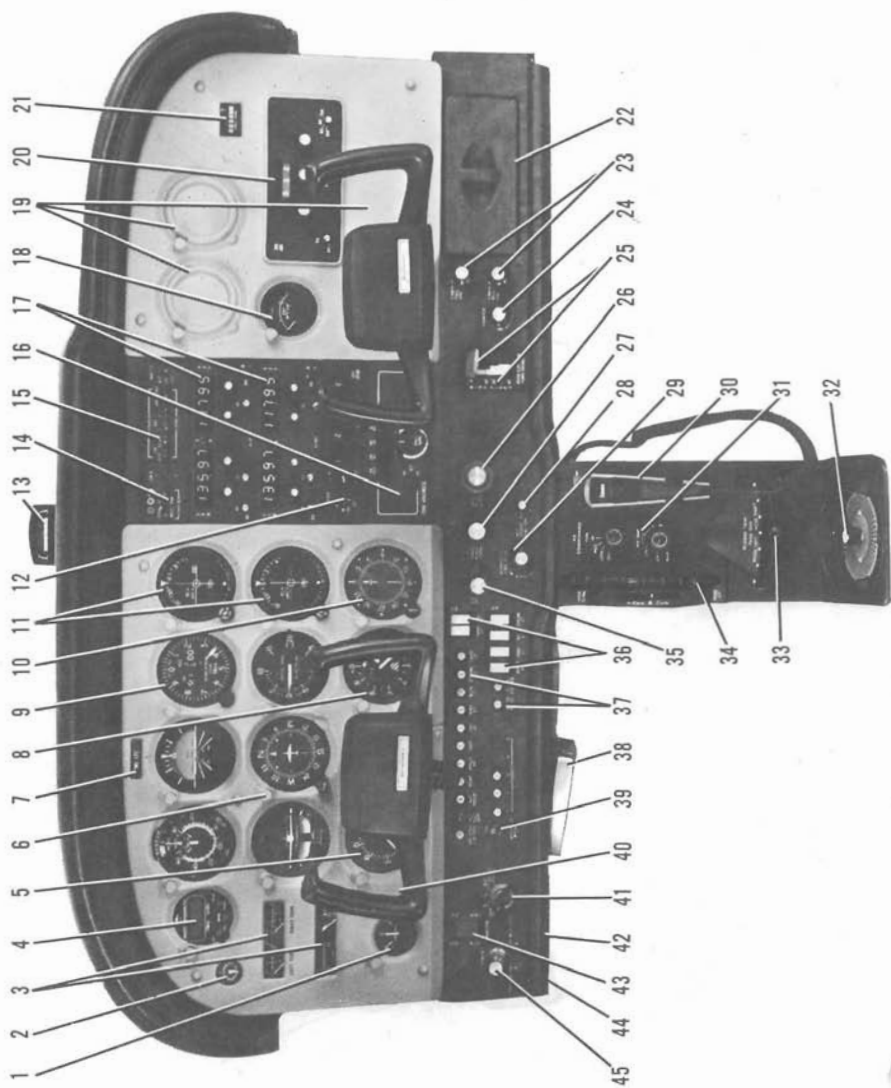

Figure 7-2. Instrument Panel (Sheet 1 of 2)

1. Ammeter
2. Suction Gage
3. Oil Temperature, Oil Pressure, and Fuel Quantity Indicators
4. Digital Clock
5. Tachometer
6. Flight Instrument Group
7. Airplane Registration Number
8. Secondary Altimeter
9. Encoding Altimeter
10. ADF Bearing Indicator
11. Course Deviation Indicators
12. Transponder
13. Magnetic Compass
14. Marker Beacon Indicator
Lights and Switches
15. Audio Control Panel
16. Autopilot Control Unit
17. Radios
18. Economy Mixture Indicator
19. Additional Instrument Space
20. ADF Radio
21. Flight Hour Recorder
22. Map Compartment
23. Cabin Heat and Air Control Knobs
24. Cigar Lighter
25. Wing Flap Switch and Position Indicator
26. Mixture Control Knob
27. Throttle (With Friction Lock)
28. Static Pressure Alternate Source Valve
29. Instrument and Radio Dial
Light Dimming Rheostats
30. Microphone
31. Air Conditioning Controls
32. Fuel Selector Valve Handle
33. Rudder Trim Control Lever
34. Elevator Trim Control Wheel
35. Carburetor Heat Control Knob
36. Electrical Switches
37. Circuit Breakers
38. Parking Brake Handle
39. Avionics Power Switch
40. Low-Voltage Warning Light
41. Ignition Switch
42. Auxiliary Mike Jack
43. Master Switch
44. Phone Jack
45. Primer

Figure 7-2. Instrument Panel (Sheet 2 of 2)

The horizontal stabilizer is constructed of a forward and aft spar, ribs and stiffeners, center, left, and right wrap-around skin panels, and formed leading edge skins. The horizontal stabilizer also contains the elevator trim tab actuator. Construction of the elevator consists of formed leading edge skins, a forward spar, aft channel, ribs, torque tube and bellcrank, left upper and lower "V" type corrugated skins, and right upper and lower "V" type corrugated skins incorporating a trailing edge cut-out for the trim tab. The elevator trim tab consists of a spar, rib, and upper and lower "V" type corrugated skins. The leading edge of both left and right elevator tips incorporate extensions which contain balance weights.

FLIGHT CONTROLS

The airplane's flight control system (see figure 7-1) consists of conventional aileron, rudder, and elevator control surfaces. The control surfaces are manually operated through mechanical linkage using a control wheel for the ailerons and elevator, and rudder/brake pedals for the rudder.

Extensions are available for the rudder/brake pedals. They consist of a rudder pedal face, two spacers and two spring clips. To install an extension, place the clip on the bottom of the extension under the bottom of the rudder pedal and snap the top clip over the top of the rudder pedal. Check that the extension is firmly in place. To remove the extensions, reverse the above procedures.

TRIM SYSTEM

A manually-operated elevator trim system is provided; a rudder trim system may also be installed (see figure 7-1). Elevator trimming is accomplished through the elevator trim tab by utilizing the vertically mounted trim control wheel. Forward rotation of the trim wheel will trim nose-down; conversely, aft rotation will trim nose-up. Rudder trimming is accomplished through a bungee connected to the rudder control system and a trim lever, mounted on the control pedestal. Rudder trimming is accomplished by lifting the trim lever up to clear a detent, then moving it either left or right to the desired trim position. Moving the trim lever to the right will trim the airplane nose-right; conversely, moving the lever to the left will trim the airplane nose-left.

INSTRUMENT PANEL

The instrument panel (see figure 7-2) is designed around the basic "T" configuration. The gyros are located immediately in front of the pilot, and arranged vertically over the control column. The airspeed indicator and

altimeter are located to the left and right of the gyros, respectively. The remainder of the flight instruments are located around the basic "T". Engine instruments, fuel quantity indicators, an ammeter, and a low-voltage warning light are near the left edge of the panel. Avionics equipment is stacked approximately on the centerline of the panel, with the right side of the panel containing space for additional instruments and avionics equipment. A switch and control panel at the lower edge of the instrument panel contains the primer, master and ignition switches, avionics power switch, circuit breakers, and electrical switches on the left side, with the engine controls, light intensity controls, and static pressure alternate source valve in the center. The right side of the switch and control panel contains the wing flap switch lever and position indicator, cabin heat and air controls, cigar lighter, and map compartment. A control pedestal, installed below the switch and control panel, contains the elevator trim control wheel and position indicator, and provides a bracket for the microphone. A rudder trim control lever may be installed below the trim wheel and microphone bracket. The fuel selector valve handle is located at the base of the pedestal. A parking brake handle is mounted below the switch and control panel in front of the pilot.

For details concerning the instruments, switches, circuit breakers, and controls on this panel, refer in this section to the description of the systems to which these items are related.

GROUND CONTROL

Effective ground control while taxiing is accomplished through nose wheel steering by using the rudder pedals; left rudder pedal to steer left and right rudder pedal to steer right. When a rudder pedal is depressed, a spring-loaded steering bungee (which is connected to the nose gear and to the rudder bars) will turn the nose wheel through an arc of approximately 10° each side of center. By applying either left or right brake, the degree of turn may be increased up to 30° each side of center.

Moving the airplane by hand is most easily accomplished by attaching a tow bar to the nose gear strut. If a tow bar is not available, or pushing is required, use the wing struts as push points. Do not use the vertical or horizontal surfaces to move the airplane. If the airplane is to be towed by vehicle, never turn the nose wheel more than 30° either side of center or structural damage to the nose gear could result.

The minimum turning radius of the airplane, using differential braking and nose wheel steering during taxi, is approximately 27 feet 5 and $\frac{1}{2}$ inches. To obtain a minimum radius turn during ground handling, the airplane may be rotated around either main landing gear by pressing down on a tailcone bulkhead just forward of the horizontal stabilizer to raise the nose wheel off the ground.

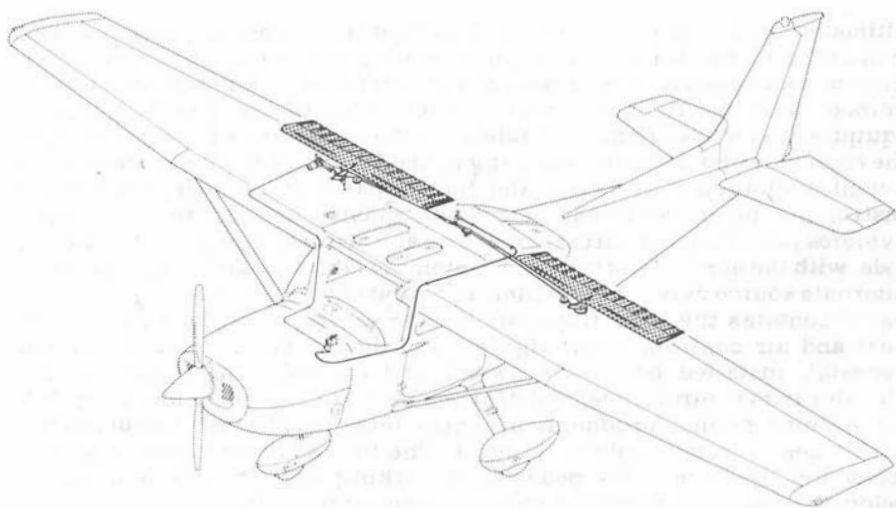

Figure 7-3. Wing Flap System

WING FLAP SYSTEM

The single-slot type wing flaps (see figure 7-3), are extended or retracted by positioning the wing flap switch lever on the instrument panel to the desired flap deflection position. The switch lever is moved up or down in a slotted panel that provides mechanical stops at the 10° and 20° positions. For flap settings greater than 10°, move the switch lever to the right to clear the stop and position it as desired. A scale and pointer on the left side of the switch lever indicates flap travel in degrees. The wing flap system circuit is protected by a 15-ampere circuit breaker, labeled FLAP, on the left side of the switch and control panel.

LANDING GEAR SYSTEM

The landing gear is of the tricycle type with a steerable nose wheel, two main wheels, and wheel fairings. Shock absorption is provided by the tubular spring-steel main landing gear struts and the air/oil nose gear shock strut. Each main gear wheel is equipped with a hydraulically actuated single-disc brake on the inboard side of each wheel, and an aerodynamic fairing over each brake.

BAGGAGE COMPARTMENT

The baggage compartment consists of two areas, one extending from behind the rear passengers' seat to the aft cabin bulkhead, and an additional area aft of the bulkhead. Access to both baggage areas is gained through a lockable baggage door on the left side of the airplane, or from within the airplane cabin. A baggage net with eight tie-down straps is provided for securing baggage and is attached by tying the straps to tie-down rings provided in the airplane. When loading the airplane, children should not be placed or permitted in the baggage compartment, unless a child's seat is installed, and any material that might be hazardous to the airplane or occupants should not be placed anywhere in the airplane. For baggage area and door dimensions, refer to Section 6.

SEATS

The seating arrangement consists of two individually adjustable four-way or six-way seats for the pilot and front seat passenger and a solid back or split-backed fixed seat for rear seat passengers. A child's seat (if installed) is located at the aft cabin bulkhead behind the rear seat.

The four-way seats may be moved forward or aft, and the angle of the seat backs is infinitely adjustable. To position the seat, lift the tubular handle below the center of the seat frame, slide the seat into position, release the handle and check that the seat is locked in place. The seat back angle is controlled by a cylinder lock release button which is spring-loaded to the locked position. The release button is located on the right side, below the forward corner of the seat cushion. To adjust the angle of the seat back, push up on the release button, position the seat back to the desired angle and release the button. When the seat is not occupied, the seat back will automatically fold forward whenever the release button is pushed up.

The six-way seats may be moved forward or aft, and are infinitely adjustable for height and seat back angle. To position either seat, lift the tubular handle under the center of the seat bottom, slide the seat into position, release the handle, and check that the seat is locked in place. Raise or lower the seat by rotating the large crank under the inboard corner of either seat. The seat back angle is adjusted by rotating the small crank under the outboard corner of either seat. The seat bottom angle will change as the seat back angle changes, providing proper support. The seat back will also fold full forward.

The rear passengers' seat consists of a fixed one-piece seat bottom with either one-piece (adjustable to the vertical position or either of two reclining positions) or two-piece (individually, infinitely adjustable) seat backs. The one-piece back is adjusted by a lever located below the center of

the seat frame. Two-piece seat backs are adjusted by cylinder lock release buttons recessed into skirts located below the seat frame at the outboard ends of the seat. To adjust the one-piece seat back, raise the lever, position the seat back to the desired angle, release the lever and check that the back is locked in place. To adjust a two-piece seat back, push up on the cylinder lock release button (which is spring-loaded to the locked position), recline the seat back to the desired position, and release the button. When the seats are not occupied, either type of seat back will automatically fold forward whenever the lever is raised or the cylinder lock release button is pushed up.

A child's seat may be installed behind the rear passengers' seat in the forward baggage compartment, and is held in place by two brackets mounted on the floorboard. When not occupied, the seat may be stowed by rotating the seat bottom up and aft until it contacts the aft cabin bulkhead.

Headrests are available for any of the seat configurations except the child's seat. To adjust the headrest, apply enough pressure to it to raise or lower it to the desired level. The headrest may be removed at any time by raising it until it disengages from the top of the seat back.

SEAT BELTS AND SHOULDER HARNESSSES

All seat positions are equipped with seat belts (see figure 7-4). The pilot's and front passenger's seats are also equipped with separate shoulder harnesses; shoulder harnesses are available for the rear seat positions. Integrated seat belt/shoulder harnesses with inertia reels can be furnished for the pilot's and front passenger's seat positions if desired.

SEAT BELTS

All of the seat belts are attached to fittings on the floorboard. The buckle half is inboard of each seat and the link half is outboard of each seat.

To use the seat belts for the front seats, position the seat as desired, and then lengthen the link half of the belt as needed by grasping the sides of the link and pulling against the belt. Insert and lock the belt link into the buckle. Tighten the belt to a snug fit. Seat belts for the rear seat and the child's seat (if installed) are used in the same manner as the belts for the front seats. To release the seat belts, grasp the top of the buckle opposite the link and pull outward.

SHOULDER HARNESSSES

Each front seat shoulder harness (see figure 7-4) is attached to a rear

**STANDARD SHOULDER
HARNES**

NARROW RELEASE STRAP
(Pull up when lengthening
harness)

FREE END OF HARNES
(Pull down to tighten)

SHOULDER HARNES
CONNECTING LINK
(Snap onto retaining stud on
seat belt link to attach harness)

SEAT BELT BUCKLE HALF
(Non adjustable)

SEAT BELT LINK HALF
AND SHOULDER HARNES
RETAINING STUD

FREE END OF SEAT BELT
(Pull to tighten)

(PILOT'S SEAT SHOWN)

SEAT BELT/SOULDER
HARNES WITH INERTIA
REEL

SEAT BELT/SOULDER HARNES
ADJUSTABLE LINK
(Position link just below shoulder
level; pull link and harness down-
ward to connect to seat belt buckle)

SEAT BELT BUCKLE
(Non adjustable)

Figure 7-4. Seat Belts and Shoulder Harnesses

doorpost above the window line and is stowed behind a stowage sheath above the cabin door. To stow the harness, fold it and place it behind the sheath. The rear seat shoulder harnesses are attached adjacent to the lower corners of the rear window. Each rear seat harness is stowed behind a stowage sheath above an aft side window. No harness is available for the child's seat.

To use a front or rear seat shoulder harness fasten and adjust the seat belt first. Lengthen the harness as required by pulling on the connecting link on the end of the harness and the narrow release strap. Snap the connecting link firmly onto the retaining stud on the seat belt link half. Then adjust to length. A properly adjusted harness will permit the occupant to lean forward enough to sit completely erect, but prevent excessive forward movement and contact with objects during sudden deceleration. Also, the pilot will want the freedom to reach all controls easily.

Removing the shoulder harness is accomplished by pulling upward on the narrow release strap, and removing the harness connecting link from the stud on the seat belt link. In an emergency, the shoulder harness may be removed by releasing the seat belt first, and allowing the harness, still attached to the link half of the seat belt, to drop to the side of the seat.

INTEGRATED SEAT BELT/SHOULDER HARNESSSES WITH INERTIA REELS

Integrated seat belt/shoulder harnesses with inertia reels are available for the pilot and front seat passenger. The seat belt/shoulder harnesses extend from inertia reels located in the cabin ceiling to attach points inboard of the two front seats. A separate seat belt half and buckle is located outboard of the seats. Inertia reels allow complete freedom of body movement. However, in the event of a sudden deceleration, they will lock automatically to protect the occupants.

NOTE

The inertia reels are located for maximum shoulder harness comfort and safe retention of the seat occupants. This location requires that the shoulder harnesses cross near the top so that the right hand inertia reel serves the pilot and the left hand reel serves the front passenger. When fastening the harness, check to ensure the proper harness is being used.

To use the seat belt/shoulder harness, position the adjustable metal link on the harness just below shoulder level, pull the link and harness downward, and insert the link into the seat belt buckle. Adjust belt tension

across the lap by pulling upward on the shoulder harness. Removal is accomplished by releasing the seat belt buckle, which will allow the inertia reel to pull the harness inboard of the seat.

ENTRANCE DOORS AND CABIN WINDOWS

Entry to, and exit from the airplane is accomplished through either of two entry doors, one on each side of the cabin at the front seat positions (refer to Section 6 for cabin and cabin door dimensions). The doors incorporate a recessed exterior door handle, a conventional interior door handle, a key-operated door lock (left door only), a door stop mechanism, and an openable window in the left door. An openable right door window is also available.

To open the doors from outside the airplane, utilize the recessed door handle near the aft edge of either door by grasping the forward edge of the handle and pulling outboard. To close or open the doors from inside the airplane, use the combination door handle and arm rest. The inside door handle has three positions and a placard at its base which reads OPEN, CLOSE, and LOCK. The handle is spring-loaded to the CLOSE (up) position. When the door has been pulled shut and latched, lock it by rotating the door handle forward to the LOCK position (flush with the arm rest). When the handle is rotated to the LOCK position, an over-center action will hold it in that position. Both cabin doors should be locked prior to flight, and should not be opened intentionally during flight.

NOTE

Accidental opening of a cabin door in flight due to improper closing does not constitute a need to land the airplane. The best procedure is to set up the airplane in a trimmed condition at approximately 75 KIAS, momentarily shove the door outward slightly, and forcefully close and lock the door.

Exit from the airplane is accomplished by rotating the door handle from the LOCK position, past the CLOSE position, aft to the OPEN position and pushing the door open. To lock the airplane, lock the right cabin door with the inside handle, close the left cabin door, and using the ignition key, lock the door.

The left cabin door is equipped with an openable window which is held in the closed position by a detent equipped latch on the lower edge of the window frame. To open the window, rotate the latch upward. The window is equipped with a spring-loaded retaining arm which will help rotate the

window outward, and hold it there. An openable window is also available for the right door, and functions in the same manner as the left window. If required, either window may be opened at any speed up to 160 KIAS. The cabin top windows (if installed), rear side windows, and rear windows are of the fixed type and cannot be opened.

CONTROL LOCKS

A control lock is provided to lock the aileron and elevator control surfaces to prevent damage to these systems by wind buffeting while the airplane is parked. The lock consists of a shaped steel rod with a red metal flag attached to it. The flag is labeled CONTROL LOCK, REMOVE BEFORE STARTING ENGINE. To install the control lock, align the hole in the top of the pilot's control wheel shaft with the hole in the top of the shaft collar on the instrument panel and insert the rod into the aligned holes. Installation of the lock will secure the ailerons in a neutral position and the elevators in a slightly trailing edge down position. Proper installation of the lock will place the red flag over the ignition switch. In areas where high or gusty winds occur, a control surface lock should be installed over the vertical stabilizer and rudder. The control lock and any other type of locking device should be removed prior to starting the engine.

ENGINE

The airplane is powered by a horizontally-opposed, four-cylinder, overhead-valve, air-cooled, carbureted engine with a wet sump oil system. The engine is a Lycoming Model O-320-H2AD and is rated at 160 horsepower at 2700 RPM. Major accessories include a starter and belt-driven alternator mounted on the front of the engine, and dual magnetos and a vacuum pump which are mounted on an accessory drive pad on the rear of the engine. Provisions are also made for a full flow oil filter.

ENGINE CONTROLS

Engine power is controlled by a throttle located on the switch and control panel above the control pedestal. The throttle operates in a conventional manner; in the full forward position, the throttle is open, and in the full aft position, it is closed. A friction lock, which is a round knurled disk, is located at the base of the throttle and is operated by rotating the lock clockwise to increase friction or counterclockwise to decrease it.

The mixture control, mounted above the right corner of the control pedestal, is a red knob with raised points around the circumference and is equipped with a lock button in the end of the knob. The rich position is full forward, and full aft is the idle cut-off position. For small adjustments, the

control may be moved forward by rotating the knob clockwise, and aft by rotating the knob counterclockwise. For rapid or large adjustments, the knob may be moved forward or aft by depressing the lock button in the end of the control, and then positioning the control as desired.

ENGINE INSTRUMENTS

Engine operation is monitored by the following instruments: oil pressure gage, oil temperature gage, and a tachometer. An economy mixture (EGT) indicator and a carburetor air temperature gage are also available.

The oil pressure gage, located on the left side of the instrument panel, is operated by oil pressure. A direct pressure oil line from the engine delivers oil at engine operating pressure to the oil pressure gage. Gage markings indicate that minimum idling pressure is 25 PSI (red line), the normal operating range is 60 to 90 PSI (green arc), and maximum pressure is 115 PSI (red line).

Oil temperature is indicated by a gage adjacent to the oil pressure gage. The gage is operated by an electrical-resistance type temperature sensor which receives power from the airplane electrical system. Oil temperature limitations are the normal operating range (green arc) which is 100° F (38°C) to 245° F (118°C), and the maximum (red line) which is 245° F (118°C).

The engine-driven mechanical tachometer is located on the instrument panel to the left of the pilot's control wheel. The instrument is calibrated in increments of 100 RPM and indicates both engine and propeller speed. An hour meter in the lower section of the dial records elapsed engine time in hours and tenths. Instrument markings include the normal operating range (multiple width green arc) of 2100 to 2700 RPM, and a maximum (red line) of 2700 RPM. The multiple width green arc has steps at 2450 RPM, 2575 RPM, and 2700 RPM which indicate a 75% engine power setting at altitudes of sea level, 5000 feet, and 10,000 feet.

An economy mixture (EGT) indicator is available for the airplane, and is located on the right side of the instrument panel. A thermocouple probe in the tailpipe measures exhaust gas temperature and transmits it to the indicator. The indicator serves as a visual aid to the pilot in adjusting cruise mixture. Exhaust gas temperature varies with fuel-to-air ratio, power, and RPM. However, the difference between the peak EGT and the EGT at the cruise mixture setting is essentially constant, and this provides a useful leaning aid. The indicator is equipped with a manually positioned reference pointer.

A carburetor air temperature gage is available for the airplane. Details

of this gage are presented in Section 9, Supplements.

NEW ENGINE BREAK-IN AND OPERATION

The engine underwent a run-in at the factory and is ready for the full range of use. It is, however, suggested that cruising be accomplished at a minimum of 75% power until a total of 50 hours has accumulated or oil consumption has stabilized. This will ensure proper seating of the rings.

ENGINE OIL SYSTEM

Oil for engine lubrication is supplied from a sump on the bottom of the engine. The capacity of the engine sump is six quarts (one additional quart is required if a full flow oil filter is installed). Oil is drawn from the sump through an oil suction strainer screen into the engine-driven oil pump. From the pump, oil is routed to a bypass valve. If the oil is cold, the bypass valve allows the oil to bypass the oil cooler and go directly from the pump to the oil pressure screen (full flow oil filter if installed). If the oil is hot, the bypass valve routes the oil out of the accessory housing and into a flexible hose leading to the oil cooler on the right, rear engine baffle. Pressure oil from the cooler returns to the accessory housing where it passes through the pressure strainer screen (full flow oil filter, if installed). The filter oil then enters a pressure relief valve which regulates engine oil pressure by allowing excessive oil to return to the sump while the balance of the oil is circulated to various engine parts for lubrication. Residual oil is returned to the sump by gravity flow.

An oil filler cap/oil dipstick is located at the rear of the engine near the center. The filler cap/dipstick is accessible through an access door in the engine cowling. The engine should not be operated on less than four quarts of oil. For extended flight, fill to six quarts (dipstick indication only). For engine oil grade and specifications, refer to Section 8 of this handbook.

An oil quick-drain valve is available to replace the drain plug on the bottom of the oil sump, and provides quicker, cleaner draining of the engine oil. To drain the oil with this valve, slip a hose over the end of the valve and push upward on the end of the valve until it snaps into the open

position. Spring clips will hold the valve open. After draining, use a suitable tool to snap the valve into the extended (closed) position and remove the drain hose.

IGNITION-STARTER SYSTEM

Engine ignition is provided by an engine-driven dual magneto, and two spark plugs in each cylinder. The right magneto fires the lower right and upper left spark plugs, and the left magneto fires the lower left and upper right spark plugs. Normal operation is conducted with both magnetos due to the more complete burning of the fuel-air mixture with dual ignition.

Ignition and starter operation is controlled by a rotary type switch located on the left switch and control panel. The switch is labeled clockwise, OFF, R, L, BOTH, and START. The engine should be operated on both magnetos (BOTH position) except for magneto checks. The R and L positions are for checking purposes and emergency use only. When the switch is rotated to the spring-loaded START position, (with the master switch in the ON position), the starter contactor is energized and the starter will crank the engine. When the switch is released, it will automatically return to the BOTH position.

AIR INDUCTION SYSTEM

The engine air induction system receives ram air through an intake in the lower front portion of the engine cowling. The intake is covered by an air filter which removes dust and other foreign matter from the induction air. Airflow passing through the filter enters an airbox. After passing through the airbox, induction air enters the inlet in the carburetor which is under the engine, and is then ducted to the engine cylinders through intake manifold tubes. In the event carburetor ice is encountered or the intake filter becomes blocked, alternate heated air can be obtained from a shroud around an exhaust riser through a duct to a valve, in the airbox, operated by the carburetor heat control on the instrument panel. Heated air from the shroud is obtained from an unfiltered outside source. Use of full carburetor heat at full throttle will result in a loss of approximately 100 to 225 RPM.

EXHAUST SYSTEM

Exhaust gas from each cylinder passes through riser assemblies to a muffler and tailpipe. The muffler is constructed with a shroud around the outside which forms a heating chamber for cabin heater air.

CARBURETOR AND PRIMING SYSTEM

The engine is equipped with an up-draft, float-type, fixed jet carburetor

mounted on the bottom of the engine. The carburetor is equipped with an enclosed accelerator pump, an idle cut-off mechanism, and a manual mixture control. Fuel is delivered to the carburetor by gravity flow from the fuel system. In the carburetor, fuel is atomized, proportionally mixed with intake air, and delivered to the cylinders through intake manifold tubes. The proportion of atomized fuel to air may be controlled, within limits, by the mixture control on the instrument panel.

For easy starting in cold weather, the engine is equipped with a manual primer. The primer is actually a small pump which draws fuel from the fuel strainer when the plunger is pulled out, and injects it into the cylinder intake ports when the plunger is pushed back in. The plunger is equipped with a lock and, after being pushed full in, must be rotated either left or right until the knob cannot be pulled out.

COOLING SYSTEM

Ram air for engine cooling enters through two intake openings in the front of the engine cowling. The cooling air is directed around the cylinders and other areas of the engine by baffling, and is then exhausted through an opening at the bottom aft edge of the cowling. No manual cooling system control is provided.

A winterization kit is available for the airplane. Details of this kit are presented in Section 9, Supplements.

PROPELLER

The airplane is equipped with a two-bladed, fixed-pitch, one-piece forged aluminum alloy propeller which is anodized to retard corrosion. The propeller is 75 inches in diameter.

FUEL SYSTEM

The airplane may be equipped with either a standard fuel system or long range system (see figure 7-6). Both systems consist of two vented fuel tanks (one in each wing), a four-position selector valve, fuel strainer, manual primer, and carburetor. Refer to figure 7-5 for fuel quantity data for both systems.

Fuel flows by gravity from the two wing tanks to a four-position selector valve, labeled BOTH, RIGHT, LEFT, and OFF. With the selector valve in either the BOTH, LEFT, or RIGHT position, fuel flows through a strainer to the carburetor. From the carburetor, mixed fuel and air flows to the cylinders through intake manifold tubes. The manual primer draws its

FUEL QUANTITY DATA (U. S. GALLONS)			
TANKS	TOTAL USABLE FUEL ALL FLIGHT CONDITIONS	TOTAL UNUSABLE FUEL	TOTAL FUEL VOLUME
STANDARD (21.5 Gal. Each)	40	3	43
LONG RANGE (27 Gal. Each)	50	4	54

Figure 7-5. Fuel Quantity Data

fuel from the fuel strainer and injects it into the cylinder intake ports.

Fuel system venting is essential to system operation. Blockage of the system will result in decreasing fuel flow and eventual engine stoppage. Venting is accomplished by an interconnecting line from the right fuel tank to the left tank. The left fuel tank is vented overboard through a vent line, equipped with a check valve, which protrudes from the bottom surface of the left wing near the wing strut. The right fuel tank filler cap is also vented.

Fuel quantity is measured by two float-type fuel quantity transmitters (one in each tank) and indicated by two electrically-operated fuel quantity indicators on the left side of the instrument panel. An empty tank is indicated by a red line and the letter E. When an indicator shows an empty tank, approximately 1.5 gallons remain in a standard tank, and 2 gallons remain in a long range tank as unusable fuel. The indicators cannot be relied upon for accurate readings during skids, slips, or unusual attitudes.

The fuel selector valve should be in the BOTH position for takeoff, climb, landing, and maneuvers that involve prolonged slips or skids. Operation from either LEFT or RIGHT tank is reserved for cruising flight.

NOTE

When the fuel selector valve handle is in the BOTH position in cruising flight, unequal fuel flow from each tank may occur if the wings are not maintained exactly level. Resulting wing heaviness can be alleviated gradually by turning the selector valve handle to the tank in the "heavy" wing.

NOTE

It is not practical to measure the time required to consume

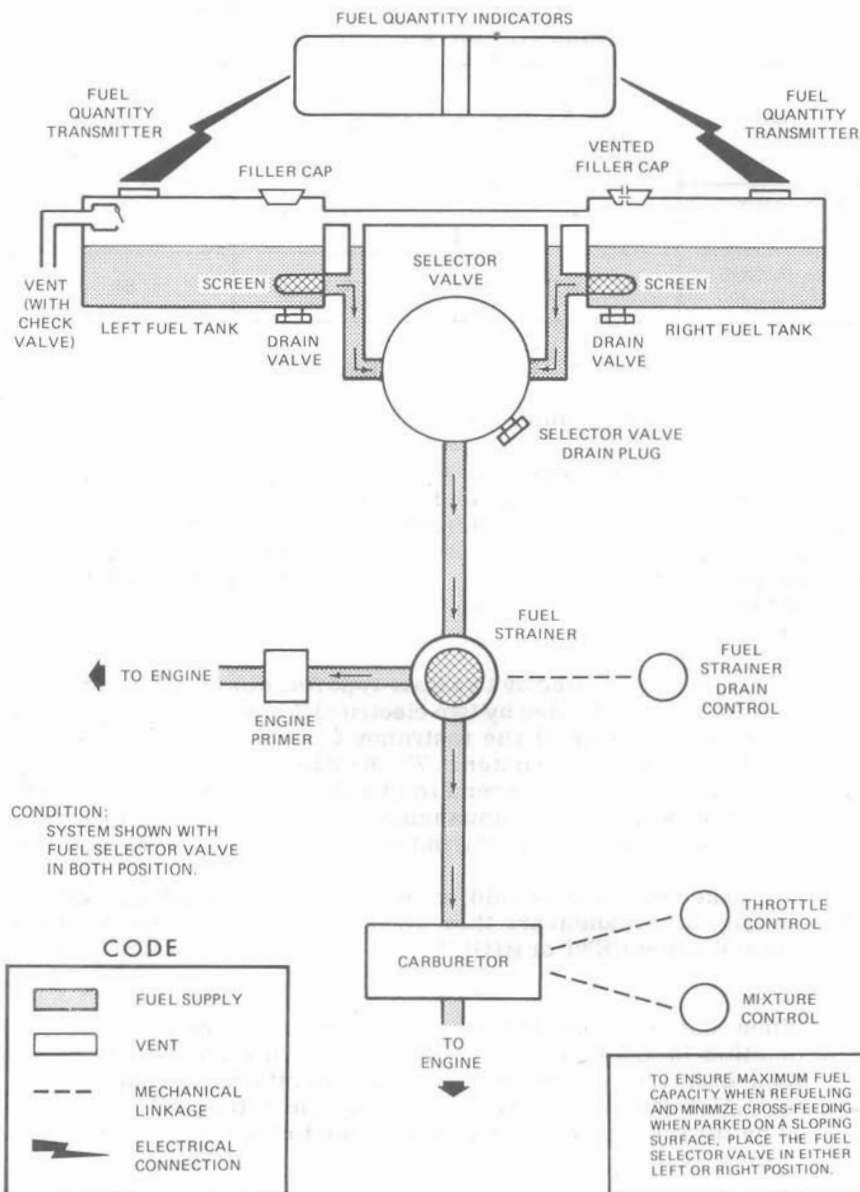

Figure 7-6. Fuel System (Standard and Long Range)

all of the fuel in one tank, and, after switching to the opposite tank, expect an equal duration from the remaining fuel. The airspace in both fuel tanks is interconnected by a vent line and, therefore, some sloshing of fuel between tanks can be expected when the tanks are nearly full and the wings are not level.

The fuel system is equipped with drain valves to provide a means for the examination of fuel in the system for contamination and grade. The system should be examined before the first flight of every day and after each refueling, by using the sampler cup provided to drain fuel from the wing tank sumps, and by utilizing the fuel strainer drain under an access panel on the right side of the engine cowling. The fuel tanks should be filled after each flight to prevent condensation.

BRAKE SYSTEM

The airplane has a single-disc, hydraulically-actuated brake on each main landing gear wheel. Each brake is connected, by a hydraulic line, to a master cylinder attached to each of the pilot's rudder pedals. The brakes are operated by applying pressure to the top of either the left (pilot's) or right (copilot's) set of rudder pedals, which are interconnected. When the airplane is parked, both main wheel brakes may be set by utilizing the parking brake which is operated by a handle under the left side of the instrument panel. To apply the parking brake, set the brakes with the rudder pedals, pull the handle aft, and rotate it 90° down.

For maximum brake life, keep the brake system properly maintained, and minimize brake usage during taxi operations and landings.

Some of the symptoms of impending brake failure are: gradual decrease in braking action after brake application, noisy or dragging brakes, soft or spongy pedals, and excessive travel and weak braking action. If any of these symptoms appear, the brake system is in need of immediate attention. If, during taxi or landing roll, braking action decreases, let up on the pedals and then re-apply the brakes with heavy pressure. If the brakes become spongy or pedal travel increases, pumping the pedals should build braking pressure. If one brake becomes weak or fails, use the other brake sparingly while using opposite rudder, as required, to offset the good brake.

ELECTRICAL SYSTEM

The airplane is equipped with a 28-volt, direct-current electrical system (see figure 7-7). The system is powered by a belt-driven, 60-amp

SECTION 7
AIRPLANE & SYSTEMS DESCRIPTIONS

CESSNA
MODEL 172N

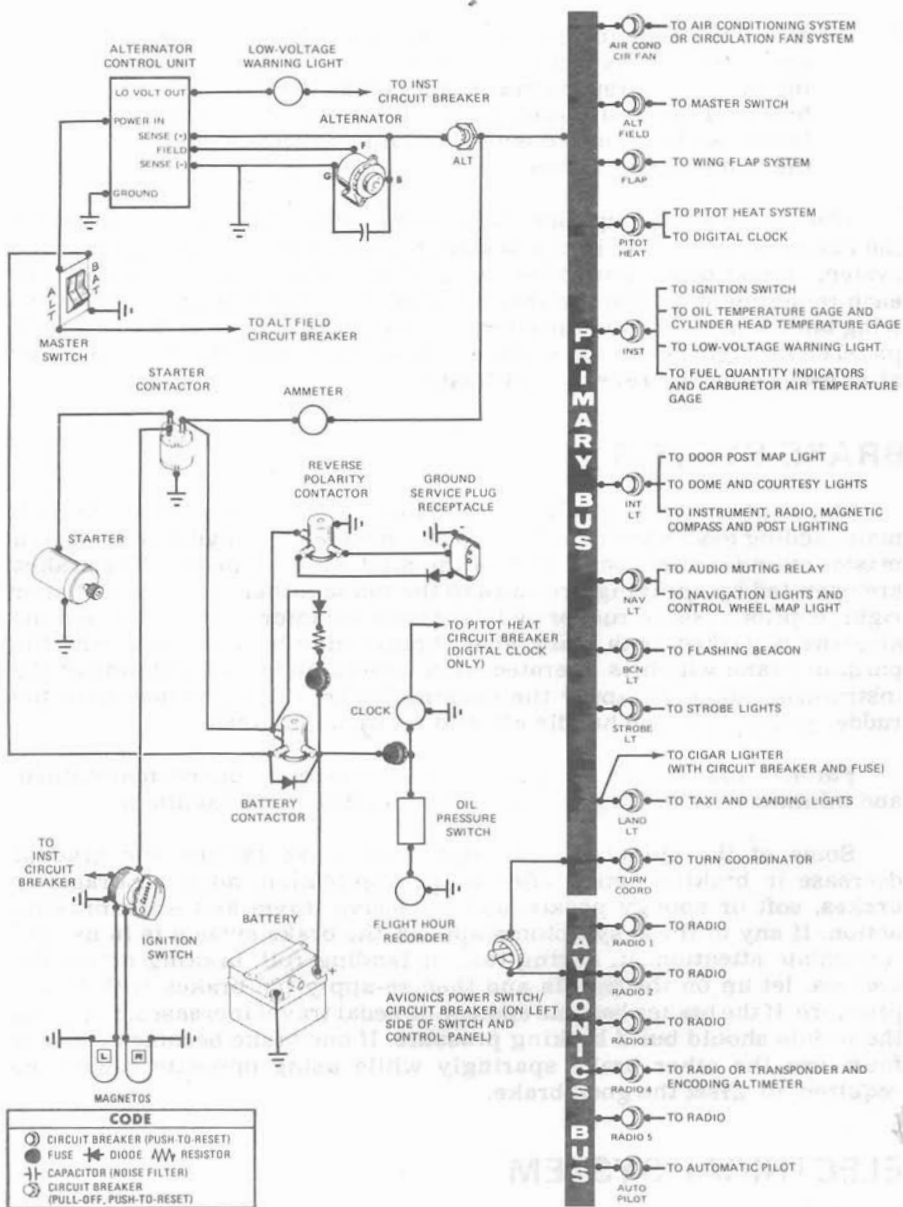

Figure 7-7. Electrical System

alternator and a 24-volt battery (a heavy duty battery is available), located on the left forward side of the firewall. Power is supplied to most general electrical and all avionics circuits through the primary bus bar and the avionics bus bar, which are interconnected by an avionics power switch. The primary bus is on anytime the master switch is turned on, and is not affected by starter or external power usage. Both bus bars are on anytime the master and avionics power switches are turned on.

CAUTION

Prior to turning the master switch on or off, starting the engine or applying an external power source, the avionics power switch, labeled AVIONICS POWER, should be turned off to prevent any harmful transient voltage from damaging the avionics equipment.

MASTER SWITCH

The master switch is a split-rocker type switch labeled MASTER, and is ON in the up position and off in the down position. The right half of the switch, labeled BAT, controls all electrical power to the airplane. The left half, labeled ALT, controls the alternator.

Normally, both sides of the master switch should be used simultaneously; however, the BAT side of the switch could be turned on separately to check equipment while on the ground. To check or use avionics equipment or radios while on the ground, the avionics power switch must also be turned on. The ALT side of the switch, when placed in the off position, removes the alternator from the electrical system. With this switch in the off position, the entire electrical load is placed on the battery. Continued operation with the alternator switch in the off position will reduce battery power low enough to open the battery contactor, remove power from the alternator field, and prevent alternator restart.

AVIONICS POWER SWITCH

Electrical power from the airplane primary bus to the avionics bus (see figure 7-7) is controlled by a toggle switch/circuit breaker labeled AVIONICS POWER. The switch is located on the left side of the switch and control panel and is ON in the up position and off in the down position. With the switch in the off position, no electrical power will be applied to the avionics equipment, regardless of the position of the master switch or the individual equipment switches. The avionics power switch also functions as a circuit breaker. If an electrical malfunction should occur and cause the circuit breaker to open, electrical power to the avionics equipment will be

interrupted and the switch will automatically move to the off position. If this occurs, allow the circuit breaker to cool approximately two minutes before placing the switch in the ON position again. If the circuit breaker opens again, do not reset it. The avionics power switch should be placed in the off position prior to turning the master switch ON or off, starting the engine, or applying an external power source, and may be utilized in place of the individual avionics equipment switches.

AMMETER

The ammeter, located on the lower left side of the instrument panel, indicates the amount of current, in amperes, from the alternator to the battery or from the battery to the airplane electrical system. When the engine is operating and the master switch is turned on, the ammeter indicates the charging rate applied to the battery. In the event the alternator is not functioning or the electrical load exceeds the output of the alternator, the ammeter indicates the battery discharge rate.

ALTERNATOR CONTROL UNIT AND LOW-VOLTAGE WARNING LIGHT

The airplane is equipped with a combination alternator regulator high-low voltage control unit mounted on the engine side of the firewall and a red warning light, labeled LOW VOLTAGE, on the left side of the instrument panel below the ammeter.

In the event an over-voltage condition occurs, the alternator control unit automatically removes alternator field current which shuts down the alternator. The battery will then supply system current as shown by a discharge rate on the ammeter. Under these conditions, depending on electrical system load, the low-voltage warning light will illuminate when system voltage drops below normal. The alternator control unit may be reset by turning the master switch off and back on again. If the warning light does not illuminate, normal alternator charging has resumed; however, if the light does illuminate again, a malfunction has occurred, and the flight should be terminated as soon as practicable.

NOTE

Illumination of the low-voltage light and ammeter discharge indications may occur during low RPM conditions with an electrical load on the system, such as during a low RPM taxi. Under these conditions, the light will go out at higher RPM. The master switch need not be recycled since an over-voltage condition has not occurred to de-activate the alternator system.

The warning light may be tested by turning on the landing lights and momentarily turning off the ALT portion of the master switch while leaving the BAT portion turned on.

CIRCUIT BREAKERS AND FUSES

Most of the electrical circuits in the airplane are protected by "push-to-reset" type circuit breakers mounted on the left side of the switch and control panel. However, alternator output is protected by a "pull-off" type circuit breaker. In addition to the individual circuit breakers, a toggle switch/circuit breaker, labeled AVIONICS POWER, on the left side of the switch and control panel also protects the avionics systems. The cigar lighter is protected by a manually-reset type circuit breaker on the back of the lighter, and a fuse behind the instrument panel. The control wheel map light (if installed) is protected by the NAV LT circuit breaker and a fuse behind the instrument panel. Electrical circuits which are not protected by circuit breakers are the battery contactor closing (external power) circuit, clock circuit, and flight hour recorder circuit. These circuits are protected by fuses mounted adjacent to the battery.

GROUND SERVICE PLUG RECEPTACLE

A ground service plug receptacle may be installed to permit the use of an external power source for cold weather starting and during lengthy maintenance work on the electrical and electronic equipment. Details of the ground service plug receptacle are presented in Section 9, Supplements.

LIGHTING SYSTEMS

EXTERIOR LIGHTING

Conventional navigation lights are located on the wing tips and top of the rudder. A single landing light is located in the cowl nose cap. Dual landing/taxi lights are available and also located in the cowl nose cap. Additional lighting is available and includes a flashing beacon mounted on top of the vertical fin, a strobe light on each wing tip, and a courtesy light recessed into the lower surface of each wing slightly outboard of the cabin doors. Details of the strobe light system are presented in Section 9, Supplements. The courtesy lights are operated by the DOME LIGHTS switch located on the overhead console; push the switch to the right to turn the lights on. The remaining exterior lights are operated by rocker switches located on the left switch and control panel; push the rocker up to the ON position.

The flashing beacon should not be used when flying through clouds or

overcast; the flashing light reflected from water droplets or particles in the atmosphere, particularly at night, can produce vertigo and loss of orientation.

INTERIOR LIGHTING

Instrument panel and switch and control panel lighting is provided by flood lighting, integral lighting, and post lighting (if installed). Lighting intensity is controlled by a dual light dimming rheostat equipped with an outer knob labeled PANEL LT, and an inner knob labeled RADIO LT, located below the throttle. A slide-type switch (if installed) on the overhead console, labeled PANEL LIGHTS, is used to select flood lighting in the FLOOD position, post lighting in the POST position, or a combination of post and flood lighting in the BOTH position.

Instrument panel and switch and control panel flood lighting consists of a single red flood light in the forward edge of the overhead console. To use flood lighting, move the slide switch in the overhead console, labeled PANEL LIGHTS, to the FLOOD position and rotate the outer knob on the light dimming rheostat, labeled PANEL LT, clockwise to the desired light intensity.

Post lights (if installed) are mounted at the edge of each instrument and provide direct lighting. To use post lighting, move the slide switch in the overhead console, labeled PANEL LIGHTS, to the POST position and rotate the outer knob on the light dimming rheostat, labeled PANEL LT, clockwise to obtain the desired light intensity. When the PANEL LIGHTS switch is placed in the BOTH position, the flood lights and post lights will operate simultaneously.

The engine instrument cluster (if post lights are installed), radio equipment, and magnetic compass have integral lighting and operate independently of post or flood lighting. The intensity of this lighting is controlled by the inner knob on the light dimming rheostat labeled RADIO LT; rotate the knob clockwise to obtain the desired light intensity. However, for daylight operation, the compass and engine instrument lights may be turned off while still maintaining maximum light intensity for the digital readouts in the radio equipment. This is accomplished by rotating the RADIO LT knob full counterclockwise. Check that the flood lights/post lights are turned off for daylight operation by rotating the PANEL LT knob full counterclockwise.

A cabin dome light, in the aft part of the overhead console, is operated by a switch near the light. To turn the light on, move the switch to the right.

A control wheel map light is available and is mounted on the bottom of the pilot's control wheel. The light illuminates the lower portion of the

cabin just forward of the pilot and is helpful when checking maps and other flight data during night operations. To operate the light, first turn on the NAV LT switch; then adjust the map light's intensity with the knurled disk type rheostat control located at the bottom of the control wheel.

A doorpost map light is located on the left forward doorpost. It contains both red and white bulbs and may be positioned to illuminate any area desired by the pilot. The light is controlled by a switch, below the light, which is labeled RED, OFF, and WHITE. Placing the switch in the top position will provide a red light. In the bottom position, standard white lighting is provided. In the center position, the map light is turned off. Red light intensity is controlled by the outer knob on the light dimming rheostat labeled PANEL LT.

The most probable cause of a light failure is a burned out bulb; however, in the event any of the lighting systems fail to illuminate when turned on, check the appropriate circuit breaker. If the circuit breaker has opened (white button popped out), and there is no obvious indication of a short circuit (smoke or odor), turn off the light switch of the affected lights, reset the breaker, and turn the switch on again. If the breaker opens again, do not reset it.

CABIN HEATING, VENTILATING AND DEFROSTING SYSTEM

The temperature and volume of airflow into the cabin can be regulated by manipulation of the push-pull CABIN HT and CABIN AIR control knobs (see figure 7-8).

For cabin ventilation, pull the CABIN AIR knob out. To raise the air temperature, pull the CABIN HT knob out approximately 1/4 to 1/2 inch for a small amount of cabin heat. Additional heat is available by pulling the knob out farther; maximum heat is available with the CABIN HT knob pulled out and the CABIN AIR knob pushed full in. When no heat is desired in the cabin, the CABIN HT knob is pushed full in.

Front cabin heat and ventilating air is supplied by outlet holes spaced across a cabin manifold just forward of the pilot's and copilot's feet. Rear cabin heat and air is supplied by two ducts from the manifold, one extending down each side of the cabin to an outlet at the front doorpost at floor level. Windshield defrost air is also supplied by two ducts leading from the cabin manifold to defroster outlets near the lower edge of the windshield. Two knobs control sliding valves in either defroster outlet to permit regulation of defroster airflow.

Separate adjustable ventilators supply additional air; one near each

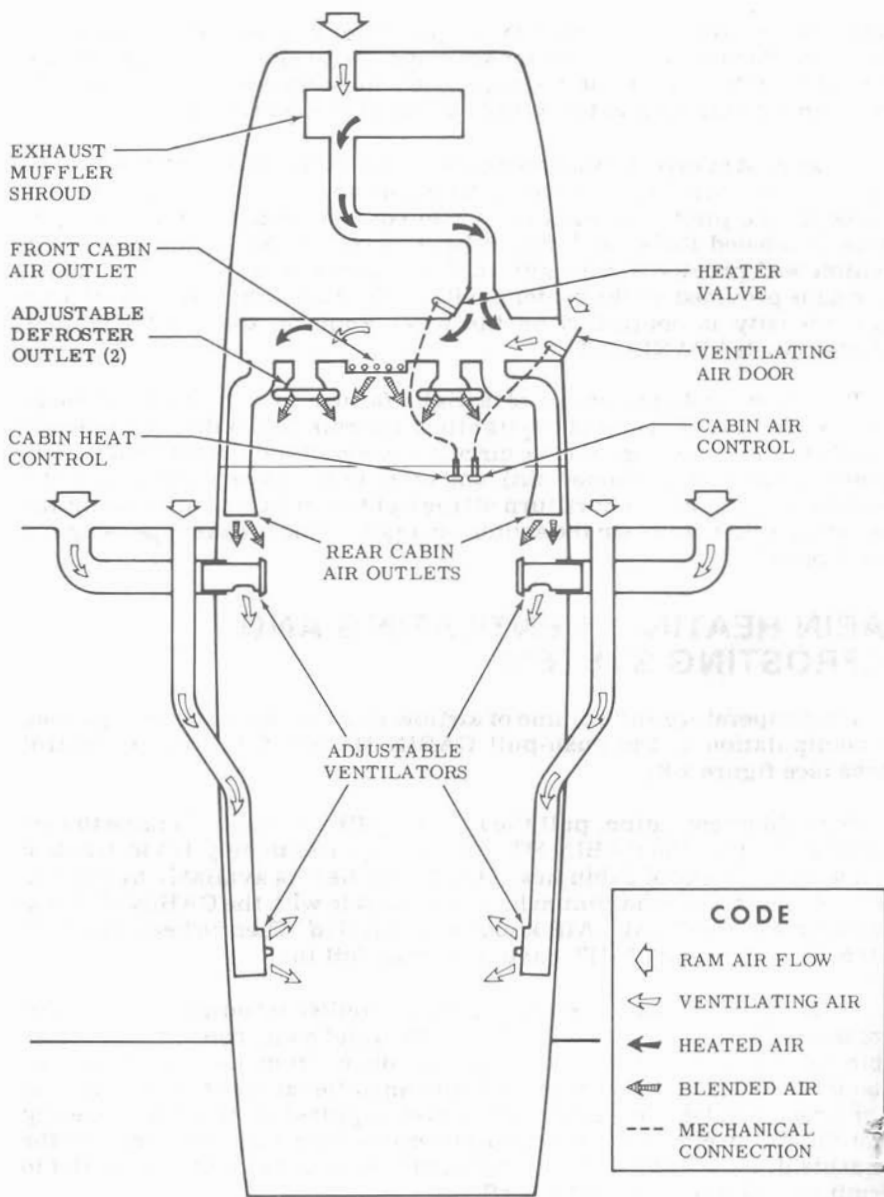

Figure 7-8. Cabin Heating, Ventilating, and Defrosting System

upper corner of the windshield supplies air for the pilot and copilot, and two ventilators are available for the rear cabin area to supply air to the rear seat passengers. The airplane may also be equipped with an air conditioning system. For operating instructions and details concerning this system, refer to Section 9, Supplements.

PITOT-STATIC SYSTEM AND INSTRUMENTS

The pitot-static system supplies ram air pressure to the airspeed indicator and static pressure to the airspeed indicator, vertical speed indicator and altimeter. The system is composed of either an unheated or heated pitot tube mounted on the lower surface of the left wing, an external static port on the lower left side of the forward fuselage, and the associated plumbing necessary to connect the instruments to the sources.

The heated pitot system (if installed) consists of a heating element in the pitot tube, a rocker switch labeled PITOT HT, a 5-amp circuit breaker, and associated wiring. The switch and circuit breaker are located on the left side of the switch and control panel. When the pitot heat switch is turned on, the element in the pitot tube is heated electrically to maintain proper operation in possible icing conditions. Pitot heat should be used only as required.

A static pressure alternate source valve may be installed on the switch and control panel below the throttle, and can be used if the external static source is malfunctioning. This valve supplies static pressure from inside the cabin instead of the external static port.

If erroneous instrument readings are suspected due to water or ice in the pressure line going to the standard external static pressure source, the alternate static source valve should be pulled on.

Pressures within the cabin will vary with open heater/vents and windows. Refer to Section 5 for the effect of varying cabin pressures on airspeed readings.

AIRSPEED INDICATOR

The airspeed indicator is calibrated in knots and miles per hour. Limitation and range markings (in KIAS) include the white arc (33 to 85 knots), green arc (44 to 127 knots), yellow arc (127 to 158 knots), and a red line (158 knots).

If a true airspeed indicator is installed, it is equipped with a rotatable ring which works in conjunction with the airspeed indicator dial in a manner similar to the operation of a flight computer. To operate the

indicator, first rotate the ring until **pressure** altitude is aligned with outside air temperature in degrees Fahrenheit. Pressure altitude should not be confused with indicated altitude. To obtain pressure altitude, momentarily set the barometric scale on the altimeter to 29.92 and read pressure altitude on the altimeter. Be sure to return the altimeter barometric scale to the original barometric setting after pressure altitude has been obtained. Having set the ring to correct for altitude and temperature, read the true airspeed shown on the rotatable ring by the indicator pointer. For best accuracy, the indicated airspeed should be corrected to calibrated airspeed by referring to the Airspeed Calibration chart in Section 5. Knowing the calibrated airspeed, read true airspeed on the ring opposite the calibrated airspeed.

VERTICAL SPEED INDICATOR

The vertical speed indicator depicts airplane rate of climb or descent in feet per minute. The pointer is actuated by atmospheric pressure changes resulting from changes of altitude as supplied by the static source.

ALTIMETER

Airplane altitude is depicted by a barometric type altimeter. A knob near the lower left portion of the indicator provides adjustment of the instrument's barometric scale to the current altimeter setting.

VACUUM SYSTEM AND INSTRUMENTS

An engine-driven vacuum system (see figure 7-9) provides the suction necessary to operate the attitude indicator and directional indicator. The system consists of a vacuum pump mounted on the engine, a vacuum relief valve and vacuum system air filter on the aft side of the firewall below the instrument panel, and instruments (including a suction gage) on the left side of the instrument panel.

ATTITUDE INDICATOR

The attitude indicator gives a visual indication of flight attitude. Bank attitude is presented by a pointer at the top of the indicator relative to the bank scale which has index marks at 10°, 20°, 30°, 60°, and 90° either side of the center mark. Pitch and roll attitudes are presented by a miniature airplane superimposed over a symbolic horizon area divided into two sections by a white horizon bar. The upper "blue sky" area and the lower "ground" area have arbitrary pitch reference lines useful for pitch attitude control. A knob at the bottom of the instrument is provided for in-flight adjustment of the miniature airplane to the horizon bar for a more accurate flight attitude indication.

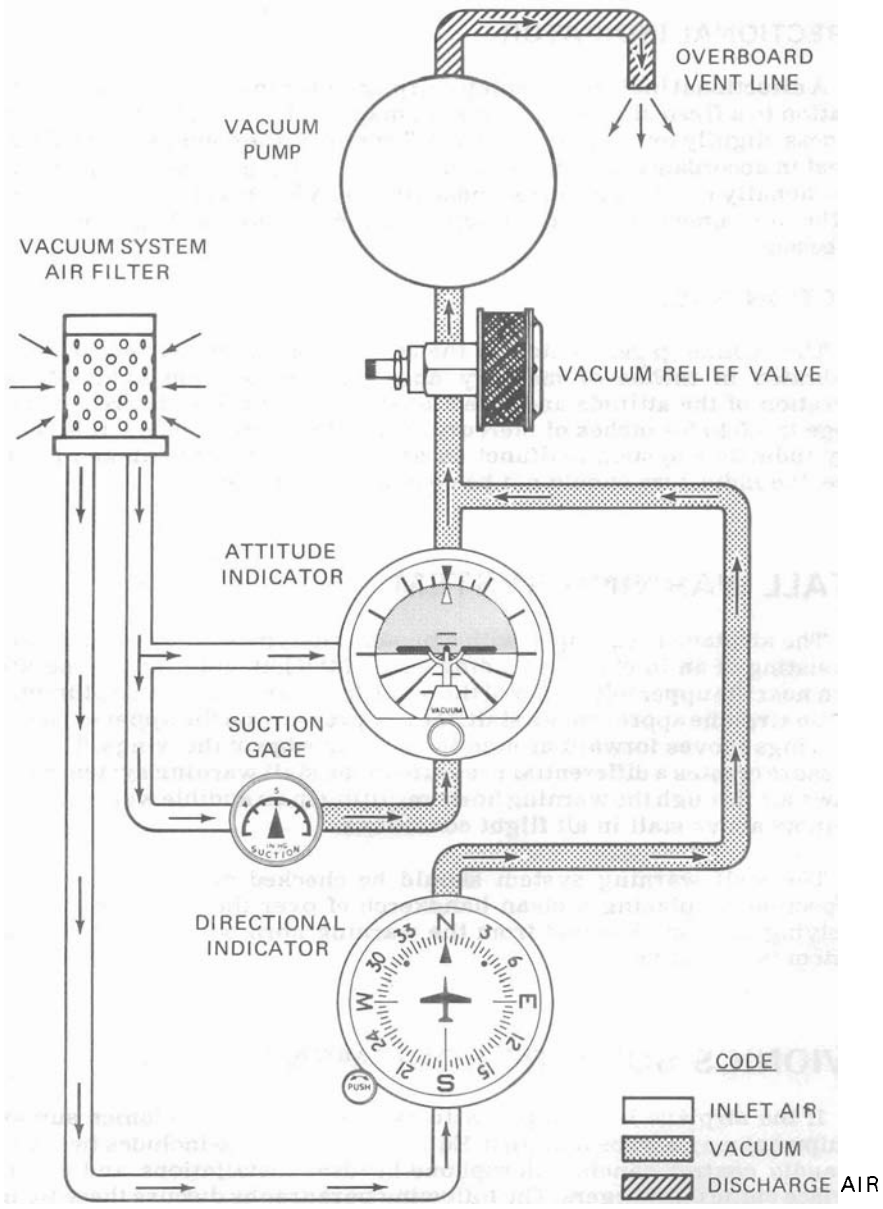

Figure 7-9. Vacuum System

DIRECTIONAL INDICATOR

A directional indicator displays airplane heading on a compass card in relation to a fixed simulated airplane image and index. The indicator will precess slightly over a period of time. Therefore, the compass card should be set in accordance with the magnetic compass just prior to takeoff, and occasionally re-adjusted on extended flights. A knob on the lower left edge of the instrument is used to adjust the compass card to correct for precession.

SUCTION GAGE

The suction gage, located on the left side of the instrument panel, is calibrated in inches of mercury and indicates suction available for operation of the attitude and directional indicators. The desired suction range is 4.5 to 5.4 inches of mercury. A suction reading below this range may indicate a system malfunction or improper adjustment, and in this case, the indicators should not be considered reliable.

STALL WARNING SYSTEM

The airplane is equipped with a pneumatic-type stall warning system consisting of an inlet in the leading edge of the left wing, an air-operated horn near the upper left corner of the windshield, and associated plumbing. As the airplane approaches a stall, the low pressure on the upper surface of the wings moves forward around the leading edge of the wings. This low pressure creates a differential pressure in the stall warning system which draws air through the warning horn, resulting in an audible warning at 5 to 10 knots above stall in all flight conditions.

The stall warning system should be checked during the preflight inspection by placing a clean handkerchief over the vent opening and applying suction. A sound from the warning horn will confirm that the system is operative.

AVIONICS SUPPORT EQUIPMENT

If the airplane is equipped with avionics, various avionics support equipment may also be installed. Equipment available includes two types of audio control panels, microphone-headset installations and control surface static dischargers. The following paragraphs discuss these items. Description and operation of radio equipment is covered in Section 9 of this handbook.

AUDIO CONTROL PANEL

Two types of audio control panels (see figure 7-10) are available for this airplane, depending upon how many transmitters are included. The operational features of both audio control panels are similar and are discussed in the following paragraphs.

TRANSMITTER SELECTOR SWITCH

When the avionics package includes a maximum of two transmitters, a two-position toggle-type switch, labeled XMTR, is provided to switch the microphone to the transmitter the pilot desires to use. If the airplane avionics package includes a third transmitter, the transmitter selector switch is a three-position rotary-type switch, labeled XMTR SEL. The numbers 1, 2, or 1, 2 and 3 adjacent to the selector switches correspond to the first, second and third (from top to bottom) transmitters in the avionics stack. To select a transmitter, place the transmitter selector switch in the position number corresponding to the desired transmitter.

The action of selecting a particular transmitter using the transmitter selector switch simultaneously selects the audio amplifier associated with that transmitter to provide speaker audio. For example, if the number one transmitter is selected, the audio amplifier in the number one NAV/COM is also selected and is used for ALL speaker audio. In the event the audio amplifier in use fails, as evidenced by loss of all speaker audio, selecting an alternate transmitter will reestablish speaker audio using the alternate transmitter audio amplifier. Headset audio is not affected by audio amplifier operation.

AUDIO SELECTOR SWITCHES

Both audio control panels (see figure 7-10) incorporate three-position toggle-type audio selector switches for individual control of the audio from systems installed in the airplane. These switches allow receiver audio to be directed to the airplane speaker or to a headset, and heard singly or in combination with other receivers. To hear a particular receiver on the airplane speaker, place that receiver's audio selector switch in the up (SPEAKER) position. To listen to a receiver over a headset, place that receiver's audio selector switch in the down (PHONE) position. The center (OFF) position turns off all audio from the associated receiver.

NOTE

Volume level is adjusted using the individual receiver volume controls on each radio.

A special feature of the audio control panel used when one or two

USED WITH ONE OR TWO TRANSMITTERS

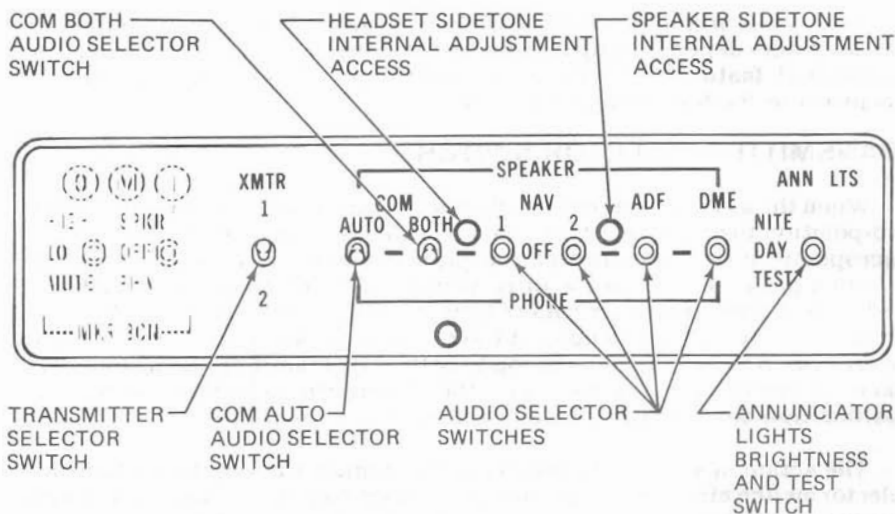

USED WITH THREE TRANSMITTERS

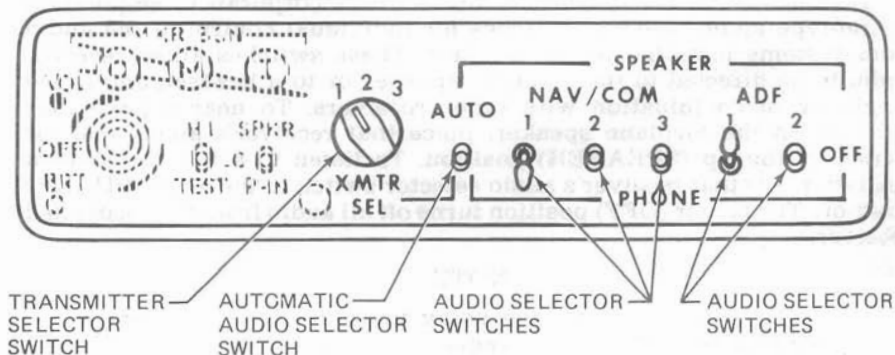

Figure 7-10. Audio Control Panel

transmitters are installed is separate control of NAV and COM audio from the NAV/COM radios. With this installation, the audio selector switches labeled NAV, 1 and 2 select audio from the navigation receivers of the NAV/COM radios only. Communication receiver audio is selected by the switches labeled COM, AUTO and BOTH. Description and operation of these switches is described in later paragraphs.

When the audio control panel for three transmitters is installed, audio from both NAV and COM frequencies is combined, and is selected by the audio selector switches labeled NAV/COM, 1, 2 and 3.

COM AUTO AUDIO SELECTOR SWITCH

The audio control panel used with either one or two transmitters incorporates a three-position toggle switch, labeled COM AUTO, which is provided to automatically match the audio of the appropriate NAV/COM communications receiver to the transmitter selected by the transmitter selector switch. When the COM AUTO selector switch is placed in the up (SPEAKER) position, audio from the communications receiver selected by the transmitter selector switch will be heard on the airplane speaker. Switching the transmitter selector switch to the other transmitter automatically switches the other communications receiver audio to the speaker. This automatic audio switching feature may also be utilized when listening on a headset by placing the COM AUTO switch in the down (PHONE) position. If automatic audio selection is not desired, the COM AUTO selector switch should be placed in the center (OFF) position.

COM BOTH AUDIO SELECTOR SWITCH

The audio control panel used with either one or two transmitters incorporates a three-position toggle switch, labeled COM BOTH, which is provided to allow both COM receivers to be monitored at the same time. For example, if the COM AUTO switch is in the SPEAKER position, with the transmitter selector switch in the number one transmitter position, number one communications receiver audio will be heard on the airplane speaker. If it is also desired to monitor the number two communications receiver audio without changing the position of the transmitter selector switch, place the COM BOTH selector switch in the up (SPEAKER) position so that the number two communications receiver audio will be heard in addition to the number one communications receiver audio. This feature can also be used when listening on a headset by placing the COM BOTH audio selector switch in the down (PHONE) position.

NOTE

The combination of placing the COM AUTO switch in the SPEAKER position and the COM BOTH switch in the

PHONE position (or vice versa) is not normally recommended as it will cause audio from both communications receivers (and any other navigation receiver with its audio selector switch in the PHONE position) to be heard on both the airplane speaker and the headset simultaneously.

AUTO AUDIO SELECTOR SWITCH

The audio control panel used with three transmitters incorporates a three-position toggle switch, labeled AUTO, which is provided to automatically match the audio of the appropriate NAV/COM receiver to the selected transmitter. To utilize this automatic feature, leave all NAV/COM audio selector switches in the center (OFF) position, and place the AUTO selector switch in either the SPEAKER or PHONE position, as desired. Once the AUTO selector switch is positioned, the pilot may then select any transmitter and its associated NAV/COM receiver audio simultaneously with the transmitter selector switch. If automatic audio selection is not desired, the AUTO selector switch should be placed in the center (OFF) position.

NOTE

If the NAV/COM audio selector switch corresponding to the selected transmitter is in the PHONE position with the AUTO selector switch in the SPEAKER position, all audio selector switches placed in the PHONE position will automatically be connected to both the airplane speaker and any headsets in use.

ANNUNCIATOR LIGHTS BRIGHTNESS AND TEST SWITCH

The audio control panel used with either one or two transmitters incorporates a three-position toggle-type switch to control the brightness level of the marker beacon indicator lights (and certain other annunciator lights associated with avionics equipment). When the switch is placed in the center (DAY) position, the indicator lights will show full bright. When this switch is placed in the up (NITE) position, the lights are set to a reduced level for typical night operations and can be further adjusted using the RADIO LT dimming rheostat knob. The down (TEST) position illuminates all lamps (except the ARC light in the NAV indicators) which are controlled by the switch to the full bright level to verify lamp operation.

SIDETONE OPERATION

Cessna radios are equipped with sidetone capability (monitoring of the operator's own voice transmission). While adjusting sidetone, be

aware that if the sidetone volume level is set too high, audio feedback (squeal) may result when transmitting.

When the airplane has one or two transmitters, sidetone is provided in both the speaker and headset anytime the COM AUTO selector switch is utilized. Placing the COM AUTO selector switch in the OFF position will eliminate sidetone. Sidetone internal adjustments are available to the pilot through the front of the audio control panel (see figure 7-10). Adjustment can be made by removing the appropriate plug-button from the audio control panel (left button for headset adjustment and right button for speaker adjustment), inserting a small screwdriver into the adjustment potentiometer and rotating it clockwise to increase the sidetone volume level.

When the airplane has three transmitters, sidetone will be heard on either the speaker or a headset as selected with the AUTO selector switch. Sidetone may be eliminated by placing the AUTO selector switch in the OFF position, and utilizing the individual audio selector switches. Adjustment of speaker and headset sidetone volume can only be accomplished by adjusting the sidetone potentiometers located inside the audio control panel.

NOTE

Sidetone is not available on HF Transceivers (Types PT10-A and ASB-125), when installed.

MICROPHONE-HEADSET INSTALLATIONS

Three types of microphone-headset installations are offered. The standard system provided with avionics equipment includes a hand-held microphone and separate headset. The keying switch for this microphone is on the microphone. Two optional microphone-headset installations are also available; these feature a single-unit microphone-headset combination which permits the pilot to conduct radio communications without interrupting other control operations to handle a hand-held microphone. One microphone-headset combination is offered without a padded headset and the other version has a padded headset. The microphone-headset combinations utilize a remote keying switch located on the left grip of the pilot's control wheel. The microphone and headset jacks are located near the lower left corner of the instrument panel. Audio to all three headsets is controlled by the individual audio selector switches and adjusted for volume level by using the selected receiver volume controls.

NOTE

When transmitting, the pilot should key the microphone, place the microphone as close as possible to the lips and speak directly into it.

STATIC DISCHARGERS

If frequent IFR flights are planned, installation of wick-type static dischargers is recommended to improve radio communications during flight through dust or various forms of precipitation (rain, snow or ice crystals). Under these conditions, the build-up and discharge of static electricity from the trailing edges of the wings, rudder, elevator, propeller tips and radio antennas can result in loss of usable radio signals on all communications and navigation radio equipment. Usually the ADF is first to be affected and VHF communication equipment is the last to be affected.

Installation of static dischargers reduces interference from precipitation static, but it is possible to encounter severe precipitation static conditions which might cause the loss of radio signals, even with static dischargers installed. Whenever possible, avoid known severe precipitation areas to prevent loss of dependable radio signals. If avoidance is impractical, minimize airspeed and anticipate temporary loss of radio signals while in these areas.

SECTION 8

AIRPLANE HANDLING, SERVICE & MAINTENANCE

TABLE OF CONTENTS

	Page
Introduction	8-3
Identification Plate	8-3
Owner Follow-Up System	8-3
Publications	8-3
Airplane File	8-4
Airplane Inspection Periods	8-5
FAA Required Inspections	8-5
Cessna Progressive Care	8-6
Cessna Customer Care Program	8-6
Pilot Conducted Preventive Maintenance	8-7
Alterations Or Repairs	8-7
Ground Handling	8-7
Towing	8-7
Parking	8-8
Tie-Down	8-8
Jacking	8-8
Leveling	8-9
Flyable Storage	8-9
Servicing	8-10
Engine Oil	8-10
Fuel	8-12
Landing Gear	8-14
Cleaning And Care	8-15
Windshield-Windows	8-15
Painted Surfaces	8-15
Propeller Care	8-16
Engine Care	8-16
Interior Care	8-16

SECTION 2 AIR-CONDITIONING SERVICE & MAINTENANCE

LIST OF CONTENTS

1.0	General	1.0
2.0	Performance	2.0
3.0	Quality Assurance	3.0
4.0	Installation	4.0
5.0	Operation & Maintenance	5.0
6.0	Testing	6.0
7.0	Acceptance	7.0
8.0	Warranty	8.0
9.0	Disposal	9.0
10.0	Other	10.0
11.0	Accessories	11.0
12.0	Painted Surfaces	12.0
13.0	Interior Care	13.0
14.0	Exterior Care	14.0
15.0	Roof	15.0
16.0	Landscaping	16.0
17.0	Security And Fire	17.0
18.0	Waste/Recycling	18.0
19.0	Painted Surfaces	19.0
20.0	Interior Care	20.0
21.0	Exterior Care	21.0
22.0	Roof	22.0
23.0	Landscaping	23.0
24.0	Security And Fire	24.0
25.0	Waste/Recycling	25.0
26.0	Painted Surfaces	26.0
27.0	Interior Care	27.0
28.0	Exterior Care	28.0
29.0	Roof	29.0
30.0	Landscaping	30.0
31.0	Security And Fire	31.0
32.0	Waste/Recycling	32.0
33.0	Painted Surfaces	33.0
34.0	Interior Care	34.0
35.0	Exterior Care	35.0
36.0	Roof	36.0
37.0	Landscaping	37.0
38.0	Security And Fire	38.0
39.0	Waste/Recycling	39.0
40.0	Painted Surfaces	40.0
41.0	Interior Care	41.0
42.0	Exterior Care	42.0
43.0	Roof	43.0
44.0	Landscaping	44.0
45.0	Security And Fire	45.0
46.0	Waste/Recycling	46.0
47.0	Painted Surfaces	47.0
48.0	Interior Care	48.0
49.0	Exterior Care	49.0
50.0	Roof	50.0
51.0	Landscaping	51.0
52.0	Security And Fire	52.0
53.0	Waste/Recycling	53.0
54.0	Painted Surfaces	54.0
55.0	Interior Care	55.0
56.0	Exterior Care	56.0
57.0	Roof	57.0
58.0	Landscaping	58.0
59.0	Security And Fire	59.0
60.0	Waste/Recycling	60.0
61.0	Painted Surfaces	61.0
62.0	Interior Care	62.0
63.0	Exterior Care	63.0
64.0	Roof	64.0
65.0	Landscaping	65.0
66.0	Security And Fire	66.0
67.0	Waste/Recycling	67.0
68.0	Painted Surfaces	68.0
69.0	Interior Care	69.0
70.0	Exterior Care	70.0
71.0	Roof	71.0
72.0	Landscaping	72.0
73.0	Security And Fire	73.0
74.0	Waste/Recycling	74.0
75.0	Painted Surfaces	75.0
76.0	Interior Care	76.0
77.0	Exterior Care	77.0
78.0	Roof	78.0
79.0	Landscaping	79.0
80.0	Security And Fire	80.0
81.0	Waste/Recycling	81.0
82.0	Painted Surfaces	82.0
83.0	Interior Care	83.0
84.0	Exterior Care	84.0
85.0	Roof	85.0
86.0	Landscaping	86.0
87.0	Security And Fire	87.0
88.0	Waste/Recycling	88.0
89.0	Painted Surfaces	89.0
90.0	Interior Care	90.0
91.0	Exterior Care	91.0
92.0	Roof	92.0
93.0	Landscaping	93.0
94.0	Security And Fire	94.0
95.0	Waste/Recycling	95.0
96.0	Painted Surfaces	96.0
97.0	Interior Care	97.0
98.0	Exterior Care	98.0
99.0	Roof	99.0
100.0	Landscaping	100.0

INTRODUCTION

This section contains factory-recommended procedures for proper ground handling and routine care and servicing of your Cessna. It also identifies certain inspection and maintenance requirements which must be followed if your airplane is to retain that new-plane performance and dependability. It is wise to follow a planned schedule of lubrication and preventive maintenance based on climatic and flying conditions encountered in your locality.

Keep in touch with your Cessna Dealer and take advantage of his knowledge and experience. He knows your airplane and how to maintain it. He will remind you when lubrications and oil changes are necessary, and about other seasonal and periodic services.

IDENTIFICATION PLATE

All correspondence regarding your airplane should include the SERIAL NUMBER. The Serial Number, Model Number, Production Certificate Number (PC) and Type Certificate Number (TC) can be found on the Identification Plate, located on the lower part of the left forward doorpost. Located adjacent to the Identification Plate is a Finish and Trim Plate which contains a code describing the interior color scheme and exterior paint combination of the airplane. The code may be used in conjunction with an applicable Parts Catalog if finish and trim information is needed.

OWNER FOLLOW-UP SYSTEM

Your Cessna Dealer has an Owner Follow-Up System to notify you when he receives information that applies to your Cessna. In addition, if you wish, you may choose to receive similar notification, in the form of Service Letters, directly from the Cessna Customer Services Department. A subscription form is supplied in your Customer Care Program book for your use, should you choose to request this service. Your Cessna Dealer will be glad to supply you with details concerning these follow-up programs, and stands ready, through his Service Department, to supply you with fast, efficient, low-cost service.

PUBLICATIONS

Various publications and flight operation aids are furnished in the

airplane when delivered from the factory. These items are listed below.

- CUSTOMER CARE PROGRAM BOOK
- PILOT'S OPERATING HANDBOOK AND FAA APPROVED AIRPLANE FLIGHT MANUAL
- AVIONICS OPERATION GUIDE
- PILOT'S CHECKLISTS
- POWER COMPUTER
- CUSTOMER CARE DEALER DIRECTORY

The following additional publications, plus many other supplies that are applicable to your airplane, are available from your Cessna Dealer.

- INFORMATION MANUAL (Contains Pilot's Operating Handbook Information)
- SERVICE MANUALS AND PARTS CATALOGS FOR YOUR:
AIRPLANE
ENGINE AND ACCESSORIES
AVIONICS AND AUTOPILOT

Your Cessna Dealer has a Customer Care Supplies Catalog covering all available items, many of which he keeps on hand. He will be happy to place an order for any item which is not in stock.

NOTE

A Pilot's Operating Handbook and FAA Approved Airplane Flight Manual which is lost or destroyed may be replaced by contacting your Cessna Dealer or writing directly to the Customer Services Department, Cessna Aircraft Company, Wichita, Kansas. An affidavit containing the owner's name, airplane serial number and registration number must be included in replacement requests since the Pilot's Operating Handbook and FAA Approved Airplane Flight Manual is identified for specific airplanes only.

AIRPLANE FILE

There are miscellaneous data, information and licenses that are a part of the airplane file. The following is a checklist for that file. In addition, a periodic check should be made of the latest Federal Aviation Regulations to ensure that all data requirements are met.

- A. To be displayed in the airplane at all times:
 - 1. Aircraft Airworthiness Certificate (FAA Form 8100-2).
 - 2. Aircraft Registration Certificate (FAA Form 8050-3).
 - 3. Aircraft Radio Station License, if transmitter installed (FCC Form 556).
- B. To be carried in the airplane at all times:
 - 1. Pilot's Operating Handbook and FAA Approved Airplane Flight Manual.
 - 2. Weight and Balance, and associated papers (latest copy of the Repair and Alteration Form, FAA Form 337, if applicable).
 - 3. Equipment List.
- C. To be made available upon request:
 - 1. Airplane Log Book.
 - 2. Engine Log Book.

Most of the items listed are required by the United States Federal Aviation Regulations. Since the Regulations of other nations may require other documents and data, owners of airplanes not registered in the United States should check with their own aviation officials to determine their individual requirements.

Cessna recommends that these items, plus the Pilot's Checklists, Power Computer, Customer Care Program book and Customer Care Card, be carried in the airplane at all times.

AIRPLANE INSPECTION PERIODS

FAA REQUIRED INSPECTIONS

As required by Federal Aviation Regulations, all civil aircraft of U.S. registry must undergo a complete inspection (annual) each twelve calendar months. In addition to the required ANNUAL inspection, aircraft operated commercially (for hire) must have a complete inspection every 100 hours of operation.

The FAA may require other inspections by the issuance of airworthiness directives applicable to the airplane, engine, propeller and components. It is the responsibility of the owner/operator to ensure compliance with all applicable airworthiness directives and, when the inspections are repetitive, to take appropriate steps to prevent inadvertent noncompliance.

In lieu of the 100 HOUR and ANNUAL inspection requirements, an airplane may be inspected in accordance with a progressive inspection schedule, which allows the work load to be divided into smaller operations that can be accomplished in shorter time periods.

The CESSNA PROGRESSIVE CARE PROGRAM has been developed to provide a modern progressive inspection schedule that satisfies the complete airplane inspection requirements of both the 100 HOUR and ANNUAL inspections as applicable to Cessna airplanes. The program assists the owner in his responsibility to comply with all FAA inspection requirements, while ensuring timely replacement of life-limited parts and adherence to factory-recommended inspection intervals and maintenance procedures.

CESSNA PROGRESSIVE CARE

The Cessna Progressive Care Program has been designed to help you realize maximum utilization of your airplane at a minimum cost and downtime. Under this program, the inspection and maintenance work load is divided into smaller operations that can be accomplished in shorter time periods. The operations are recorded in a specially provided Aircraft Inspection Log as each operation is conducted.

While Progressive Care may be used on any Cessna, its benefits depend primarily on the utilization (hours flown per year) and type of operation. The procedures for both the Progressive Care Program and the 100-hour/annual inspection program have been carefully worked out by the factory and are followed by the Cessna Dealer Organization. Your Cessna Dealer can assist you in selecting the inspection program most suitable for your type of aircraft and operation. The complete familiarity of Cessna Dealers with Cessna equipment and factory-approved procedures provides the highest level of service possible at lower cost to Cessna owners.

Regardless of the inspection method selected by the owner, he should keep in mind that FAR Part 43 and FAR Part 91 establishes the requirement that properly certified agencies or personnel accomplish all required FAA inspections and most of the manufacturer recommended inspections.

CESSNA CUSTOMER CARE PROGRAM

Specific benefits and provisions of the CESSNA WARRANTY plus other important benefits for you are contained in your CUSTOMER CARE PROGRAM book supplied with your airplane. You will want to thoroughly review your Customer Care Program book and keep it in your airplane at all times.

Coupons attached to the Program book entitle you to an initial inspection and either a Progressive Care Operation No. 1 or the first 100-hour inspection within the first 6 months of ownership at no charge to you. If you take delivery from your Dealer, the initial inspection will have been performed before delivery of the airplane to you. If you pick up your airplane at the factory, plan to take it to your Dealer reasonably soon after

you take delivery, so the initial inspection may be performed allowing the Dealer to make any minor adjustments which may be necessary.

You will also want to return to your Dealer either for your first Progressive Care Operation, or at 100 hours for your first 100-hour inspection depending on which program you choose to establish for your airplane. While these important inspections will be performed for you by any Cessna Dealer, in most cases you will prefer to have the Dealer from whom you purchased the airplane accomplish this work.

PILOT CONDUCTED PREVENTIVE MAINTENANCE

A certified pilot who owns or operates an airplane not used as an air carrier is authorized by FAR Part 43 to perform limited maintenance on his airplane. Refer to FAR Part 43 for a list of the specific maintenance operations which are allowed.

NOTE

Pilots operating airplanes of other than U.S. registry should refer to the regulations of the country of certification for information on preventive maintenance that may be performed by pilots.

A Service Manual should be obtained prior to performing any preventive maintenance to ensure that proper procedures are followed. Your Cessna Dealer should be contacted for further information or for required maintenance which must be accomplished by appropriately licensed personnel.

ALTERATIONS OR REPAIRS

It is essential that the FAA be contacted **prior to** any alterations on the airplane to ensure that airworthiness of the airplane is not violated. Alterations or repairs to the airplane must be accomplished by licensed personnel.

GROUND HANDLING

TOWING

The airplane is most easily and safely maneuvered by hand with the tow-bar attached to the nose wheel. When towing with a vehicle, do not exceed the nose gear turning angle of 30° either side of center, or damage to the gear will result. If the airplane is towed or pushed over a rough surface during hangaring, watch that the normal cushioning action of the nose strut does not cause excessive vertical movement of the tail and the

resulting contact with low hangar doors or structure. A flat nose tire or deflated strut will also increase tail height.

PARKING

When parking the airplane, head into the wind and set the parking brakes. Do not set the parking brakes during cold weather when accumulated moisture may freeze the brakes, or when the brakes are overheated. Install the control wheel lock and chock the wheels. In severe weather and high wind conditions, tie the airplane down as outlined in the following paragraph.

TIE-DOWN

Proper tie-down procedure is the best precaution against damage to the parked airplane by gusty or strong winds. To tie-down the airplane securely, proceed as follows:

1. Set the parking brake and install the control wheel lock.
2. Install a surface control lock over the fin and rudder.
3. Tie sufficiently strong ropes or chains (700 pounds tensile strength) to the wing, tail, and nose tie-down fittings and secure each rope or chain to a ramp tie-down.
4. Install a pitot tube cover.

JACKING

When a requirement exists to jack the entire airplane off the ground, or when wing jack points are used in the jacking operation, refer to the Service Manual for specific procedures and equipment required.

Individual main gear may be jacked by using the jack pad which is incorporated in the main landing gear strut step bracket. When using the individual gear strut jack pad, flexibility of the gear strut will cause the main wheel to slide inboard as the wheel is raised, tilting the jack. The jack must then be lowered for a second jacking operation. **Do not** jack both main wheels simultaneously using the individual main gear jack pads.

If nose gear maintenance is required, the nose wheel may be raised off the ground by pressing down on a tailcone bulkhead, just forward of the horizontal stabilizer, and allowing the tail to rest on the tail tie-down ring.

NOTE

Do not apply pressure on the elevator or outboard stabilizer surfaces. When pushing on the tailcone, always apply pressure at a bulkhead to avoid buckling the skin.

To assist in raising and holding the nose wheel off the ground, weight

down the tail by placing sand-bags, or suitable weights, on each side of the horizontal stabilizer, next to the fuselage. If ground anchors are available, the tail should be securely tied down.

NOTE

Ensure that the nose will be held off the ground under all conditions by means of suitable stands or supports under weight supporting bulkheads near the nose of the airplane.

LEVELING

Longitudinal leveling of the airplane is accomplished by placing a level on leveling screws located on the left side of the tailcone. Deflate the nose tire and/or lower or raise the nose strut to properly center the bubble in the level. Corresponding points on both upper door sills may be used to level the airplane laterally.

FLYABLE STORAGE

Airplanes placed in non-operational storage for a maximum of 30 days or those which receive only intermittent operational use for the first 25 hours are considered in flyable storage status. Every seventh day during these periods, the propeller should be rotated by hand through five revolutions. This action "limbers" the oil and prevents any accumulation of corrosion on engine cylinder walls.

WARNING

For maximum safety, check that the ignition switch is OFF, the throttle is closed, the mixture control is in the idle cut-off position, and the airplane is secured before rotating the propeller by hand. Do not stand within the arc of the propeller blades while turning the propeller.

After 30 days, the airplane should be flown for 30 minutes or a ground runup should be made just long enough to produce an oil temperature within the lower green arc range. Excessive ground runup should be avoided.

Engine runup also helps to eliminate excessive accumulations of water in the fuel system and other air spaces in the engine. Keep fuel tanks full to minimize condensation in the tanks. Keep the battery fully charged to prevent the electrolyte from freezing in cold weather. If the airplane is to be stored temporarily, or indefinitely, refer to the Service Manual for proper storage procedures.

SERVICING

In addition to the PREFLIGHT INSPECTION covered in Section 4, COMPLETE servicing, inspection, and test requirements for your airplane are detailed in the Service Manual. The Service Manual outlines all items which require attention at specific intervals plus those items which require servicing, inspection, and/or testing at special intervals.

Since Cessna Dealers conduct all service, inspection, and test procedures in accordance with applicable Service Manuals, it is recommended that you contact your Cessna Dealer concerning these requirements and begin scheduling your airplane for service at the recommended intervals.

Cessna Progressive Care ensures that these requirements are accomplished at the required intervals to comply with the 100-hour or ANNUAL inspection as previously covered.

Depending on various flight operations, your local Government Aviation Agency may require additional service, inspections, or tests. For these regulatory requirements, owners should check with local aviation officials where the airplane is being operated.

For quick and ready reference, quantities, materials, and specifications for frequently used service items are as follows.

ENGINE OIL

GRADE AND VISCOSITY FOR TEMPERATURE RANGE --

MIL-L-22851 Ashless Dispersant Oil: The airplane was delivered from the factory with SAE 20W-50 ashless dispersant aircraft engine oil. Ashless dispersant aircraft engine oil **must be used** for all operating conditions.

NOTE

Use a minimum of 75% power for cruise during the first 50 hours of operation or until oil consumption stabilizes. Service the engine oil system with **aviation ashless dispersant oil only**.

SAE 20W-50 or SAE 15W-50 for all temperatures.

NOTE

If multi-viscosity ashless dispersant aircraft engine oil is not available, the following ashless dispersant aircraft engine oil may be used.

SAE 50 above 60°F (16°C).

SAE 40 between 30°F (-1°C) and 90°F (32°C).
SAE 30 between 0°F (-18°C) and 70°F (21°C).
SAE 20W-30 below 0°F (-18°C) to 70°F (21°C).

CAPACITY OF ENGINE SUMP -- 6 Quarts.

Do not operate on less than 4 quarts. For extended flight, fill to 6 quarts. These quantities refer to oil dipstick level readings. During oil and oil filter changes, one additional quart is required when the filter is changed.

OIL AND OIL FILTER CHANGE --

After the first 25 hours of operation, drain the engine oil sump and clean the oil pressure screen (if an oil filter is not installed). If an oil filter is installed, change the filter at this time. Refill sump with ashless dispersant oil.

On airplanes **not** equipped with an oil filter, drain the engine oil sump and clean the oil pressure screen each 50 hours thereafter.

On airplanes **which have** an oil filter, drain the engine oil sump and change the oil filter again at the first 50 hours; thereafter, the oil and filter change interval may be extended to 100-hour intervals.

Change engine oil at least every 6 months even though less than the recommended hours have accumulated. Reduce intervals for prolonged operation in dusty areas, cold climates, or when short flights and long idle periods result in sludging conditions.

NOTE

During the first 25-hour oil and filter change, a general inspection of the overall engine compartment is required. Items which are not normally checked during a preflight inspection should be given special attention. Hoses, metal lines and fittings should be inspected for signs of oil and fuel leaks, and checked for abrasions, chafing, security, proper routing and support, and evidence of deterioration. Inspect the intake and exhaust systems for cracks, evidence of leakage, and security of attachment. Engine controls and linkages should be checked for freedom of movement through their full range, security of attachment and evidence of wear. Inspect wiring for security, chafing, burning, defective insulation, loose or broken terminals, heat deterioration, and corroded terminals. Check the alternator belt in accordance with Service Manual instructions, and retighten if necessary. A periodic check of these items during subsequent servicing operations is recommended.

FUEL

APPROVED FUEL GRADES (AND COLORS) --

100LL Grade Aviation Fuel (Blue).

100 (Formerly 100/130) Grade Aviation Fuel (Green).

NOTE

Isopropyl alcohol or ethylene glycol monomethyl ether may be added to the fuel supply in quantities not to exceed 1% or .15% by volume, respectively, of the total. Refer to Fuel Additives in later paragraphs for additional information.

CAPACITY EACH STANDARD TANK -- 21.5 Gallons.

CAPACITY EACH LONG RANGE TANK -- 27 Gallons.

NOTE

To ensure maximum fuel capacity when refueling and minimize cross-feeding when parked on a sloping surface, place the fuel selector valve in either LEFT or RIGHT position.

NOTE

Service the fuel system after each flight, and keep fuel tanks full to minimize condensation in the tanks.

FUEL ADDITIVES --

Strict adherence to recommended preflight draining instructions as called for in Section 4 will eliminate any free water accumulations from the tank sumps. While small amounts of water may still remain in solution in the gasoline, it will normally be consumed and go unnoticed in the operation of the engine.

One exception to this can be encountered when operating under the combined effect of: (1) use of certain fuels, with (2) high humidity conditions on the ground (3) followed by flight at high altitude and low temperature. Under these unusual conditions, small amounts of water in solution can precipitate from the fuel stream and freeze in sufficient quantities to induce partial icing of the engine fuel system.

While these conditions are quite rare and will not normally pose a problem to owners and operators, they do exist in certain areas of the world and consequently must be dealt with, when encountered.

Therefore, to alleviate the possibility of fuel icing occurring under these unusual conditions, it is permissible to add isopropyl alcohol or ethylene glycol monomethyl ether (EGME) compound to the fuel supply.

The introduction of alcohol or EGME compound into the fuel provides two distinct effects: (1) it absorbs the dissolved water from the gasoline and (2) alcohol has a freezing temperature depressant effect.

Alcohol, if used, is to be blended with the fuel in a concentration of 1% by volume. Concentrations greater than 1% are not recommended since they can be detrimental to fuel tank materials.

The manner in which the alcohol is added to the fuel is significant because alcohol is most effective when it is completely dissolved in the fuel. To ensure proper mixing, the following is recommended:

1. For best results, the alcohol should be added during the fueling operation by pouring the alcohol directly on the fuel stream issuing from the fueling nozzle.
2. An alternate method that may be used is to premix the complete alcohol dosage with some fuel in a separate clean container (approximately 2-3 gallon capacity) and then transferring this mixture to the tank prior to the fuel operation.

Any high quality isopropyl alcohol may be used, such as Anti-Icing Fluid (MIL-F-5566) or Isopropyl Alcohol (Federal Specification TT-I-735a). Figure 8-1 provides alcohol-fuel mixing ratio information.

Ethylene glycol monomethyl ether (EGME) compound, in compliance with MIL-I-27686 or Phillips PFA-55MB, if used, must be carefully mixed with the fuel in concentrations not to exceed .15% by volume. Figure 8-1 provides EGME-fuel mixing ratio information.

CAUTION

Mixing of the EGME compound with the fuel is extremely important because a concentration in excess of that recommended (.15% by volume maximum) will result in detrimental effects to the fuel tanks, such as deterioration of protective primer and sealants and damage to O-rings and seals in the fuel system and engine components. Use only blending equipment that is recommended by the manufacturer to obtain proper proportioning.

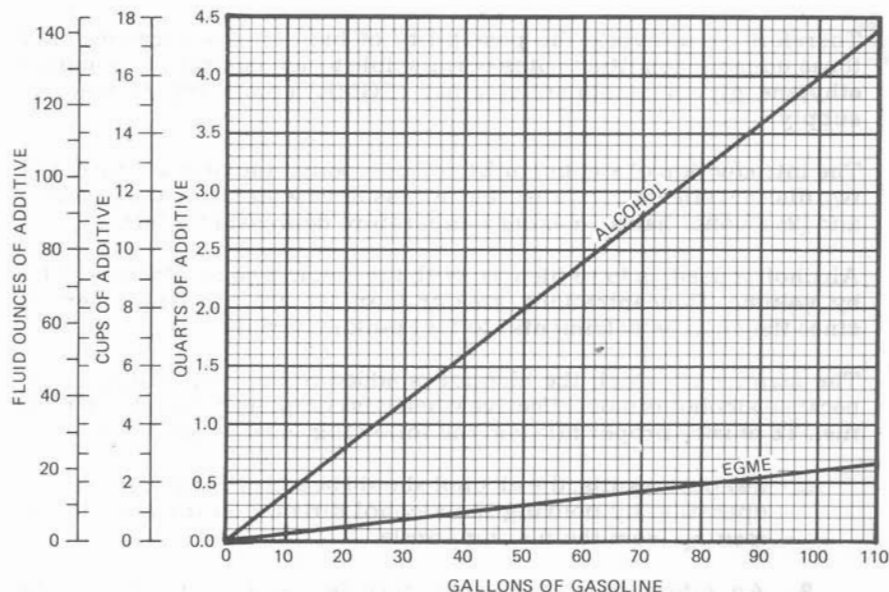

Figure 8-1. Additive Mixing Ratio

CAUTION

Do not allow the concentrated EGME compound to come in contact with the airplane finish or fuel cell as damage can result.

Prolonged storage of the airplane will result in a water buildup in the fuel which "leeches out" the additive. An indication of this is when an excessive amount of water accumulates in the fuel tank sumps. The concentration can be checked using a differential refractometer. It is imperative that the technical manual for the differential refractometer be followed explicitly when checking the additive concentration.

LANDING GEAR

NOSE WHEEL TIRE PRESSURE -- 31 PSI on 5.00-5, 4-Ply Rated Tire.
MAIN WHEEL TIRE PRESSURE -- 29 PSI on 6.00-6, 4-Ply Rated Tires.
NOSE GEAR SHOCK STRUT --

Keep filled with MIL-H-5606 hydraulic fluid and inflated with air to 45 PSI. Do not over-inflate.

CLEANING AND CARE

WINDSHIELD-WINDOWS

The plastic windshield and windows should be cleaned with an aircraft windshield cleaner. Apply the cleaner sparingly with soft cloths, and rub with moderate pressure until all dirt, oil scum and bug stains are removed. Allow the cleaner to dry, then wipe it off with soft flannel cloths.

If a windshield cleaner is not available, the plastic can be cleaned with soft cloths moistened with Stoddard solvent to remove oil and grease.

NOTE

Never use gasoline, benzine, alcohol, acetone, fire extinguisher or anti-ice fluid, lacquer thinner or glass cleaner to clean the plastic. These materials will attack the plastic and may cause it to craze.

Follow by **carefully** washing with a mild detergent and plenty of water. Rinse thoroughly, then dry with a clean moist chamois. **Do not rub** the plastic with a dry cloth since this builds up an electrostatic charge which attracts dust. Waxing with a good commercial wax will finish the cleaning job. A thin, even coat of wax, polished out by hand with clean soft flannel cloths, will fill in minor scratches and help prevent further scratching.

Do not use a canvas cover on the windshield unless freezing rain or sleet is anticipated since the cover may scratch the plastic surface.

PAINTED SURFACES

The painted exterior surfaces of your new Cessna have a durable, long lasting finish and, under normal conditions, require no polishing or buffing. Approximately 10 days are required for the paint to cure completely; in most cases, the curing period will have been completed prior to delivery of the airplane. In the event that polishing or buffing is required within the curing period, it is recommended that the work be done by someone experienced in handling uncured paint. Any Cessna Dealer can accomplish this work.

Generally, the painted surfaces can be kept bright by washing with water and mild soap, followed by a rinse with water and drying with cloths or a chamois. Harsh or abrasive soaps or detergents which cause corrosion or scratches should never be used. Remove stubborn oil and grease with a cloth moistened with Stoddard solvent.

Waxing is unnecessary to keep the painted surfaces bright. However, if

desired, the airplane may be waxed with a good automotive wax. A heavier coating of wax on the leading edges of the wings and tail and on the engine nose cap and propeller spinner will help reduce the abrasion encountered in these areas.

When the airplane is parked outside in cold climates and it is necessary to remove ice before flight, care should be taken to protect the painted surfaces during ice removal with chemical liquids. Isopropyl alcohol will satisfactorily remove ice accumulations without damaging the paint. While applying the de-icing solution, keep it away from the windshield and cabin windows since the alcohol will attack the plastic and may cause it to craze.

PROPELLER CARE

Preflight inspection of propeller blades for nicks, and wiping them occasionally with an oily cloth to clean off grass and bug stains will assure long, trouble-free service. Small nicks on the propeller, particularly near the tips and on the leading edges, should be dressed out as soon as possible since these nicks produce stress concentrations, and if ignored, may result in cracks. Never use an alkaline cleaner on the blades; remove grease and dirt with Stoddard solvent.

ENGINE CARE

The engine may be cleaned with Stoddard solvent, or equivalent, then dried thoroughly.

CAUTION

Particular care should be given to electrical equipment before cleaning. Cleaning fluids should not be allowed to enter magnetos, starter, alternator and the like. Protect these components before saturating the engine with solvents. All other openings should also be covered before cleaning the engine assembly. Caustic cleaning solutions should be used cautiously and should always be properly neutralized after their use.

INTERIOR CARE

To remove dust and loose dirt from the upholstery and carpet, clean the interior regularly with a vacuum cleaner.

Blot up any spilled liquid promptly with cleansing tissue or rags. Don't pat the spot; press the blotting material firmly and hold it for several

seconds. Continue blotting until no more liquid is taken up. Scrape off sticky materials with a dull knife, then spot-clean the area.

Oily spots may be cleaned with household spot removers, used sparingly. Before using any solvent, read the instructions on the container and test it on an obscure place on the fabric to be cleaned. Never saturate the fabric with a volatile solvent; it may damage the padding and backing materials.

Soiled upholstery and carpet may be cleaned with foam-type detergent, used according to the manufacturer's instructions. To minimize wetting the fabric, keep the foam as dry as possible and remove it with a vacuum cleaner.

If your airplane is equipped with leather seating, cleaning of the seats is accomplished using a soft cloth or sponge dipped in mild soap suds. The soap suds, used sparingly, will remove traces of dirt and grease. The soap should be removed with a clean damp cloth.

The plastic trim, headliner, instrument panel and control knobs need only be wiped off with a damp cloth. Oil and grease on the control wheel and control knobs can be removed with a cloth moistened with Stoddard solvent. Volatile solvents, such as mentioned in paragraphs on care of the windshield, must never be used since they soften and craze the plastic.

SECRET
1952

SECRET
1952

The following information was obtained from a review of the files of the Central Intelligence Agency, Office of Security, dated 10/15/52.

On 10/15/52, the following information was obtained from a review of the files of the Central Intelligence Agency, Office of Security, dated 10/15/52.

The following information was obtained from a review of the files of the Central Intelligence Agency, Office of Security, dated 10/15/52.

The following information was obtained from a review of the files of the Central Intelligence Agency, Office of Security, dated 10/15/52.

The following information was obtained from a review of the files of the Central Intelligence Agency, Office of Security, dated 10/15/52.

SECRET
1952



KONTINUERLIG VÆGT OG BALANCE OPFØLGNING

LUFTFARTØJETS REG.: 0Y - BHI

TYPE: CESSNA 172N







SERIE NR.: 172-73831

SIDE NR. 7.

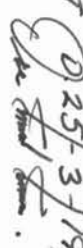
LUFTFARTØJETS DATUM:

VÆGTÆNDRING

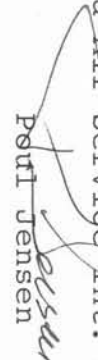
VÆGT OG BALANCE

DATO	BESKRIVELSE (vejning eller ændring) / REFERENCE	MONTERET			DEMONTERET			TOMVÆGT	TOMVÆGTS-TYNGDEPUNKT
		VÆGT	ARM	MOMENT	VÆGT	ARM	MOMENT		
25-3 1992	LUFTFARTØJET VEJET PÅ 25-31/1992 PÅ NUAS WO. 97045-7  						685,5 kg	96,5 cm	
28-4 1997	LUFTFARTØJET OMVEJET d. 28.04.97 i. H. T. NUAS WO 97090. EKTS  						1511,2	38 INCH	
11/4 2002	Luftfartøjet vejet den 11. april 2002 i. h. t. vejningsrapport fra Air Service Int. Billund  Poul Jensen						686,5 kg	101,0 cm	
25/4 2007	Luftfartøjet vejet den 25. april 2007 i. h. t. vejningsrapport fra Air Service Int. Billund  Poul Jensen						683,6 kg	101,27 cm	
							1510,805	38,56 inch	

Efter vejning af luftfartøjet skal vejningsrapport og den tilhørende grundspecifikation indsendes til Statens Luftfartsvæsen i overensstemmelse med gældende bestemmelser herfor.

Ejeren/brugeren er efter vejning og efter enhver ændring, som har betydning for luftfartøjets vægt- og balanceforhold, ansvarlig for at indføre ny tomvægt og tomvægtstygndepunkt på denne vægt- og balanceformular.